

MERITOR® HEAVY-DUTY ALTERNATORS & STARTERS



MERITOR®

TABLE OF CONTENTS

ALTERNATORS

Section 1: MEDIUM- AND HEAVY-DUTY TRUCKS

Replacement For: Delco 22, 24, 28, 33, 34, 35, 36, AD244 Series.....2-7

Replacement For: Prestolite-Leece Neville 110 Series

Section 2: COACH AND TRANSIT BUS

Replacement For: Bosch T1 Series (24V)..... 8

Section 3: DIESEL POWERED SERVICE TRUCKS

Replacement For: Dodge Sprinter & Freightliner..... 9

Section 4: REFRIGERATED TRAILERS

Replacement For: Bosch Units For Thermo King Applications 10

STARTERS

Section 5: MEDIUM- AND HEAVY-DUTY TRUCKS

Replacement For: Delco 28, 29 & 38 & 39, 42 Series..... 11-18

Section 6: COACH AND TRANSIT BUS

Replacement For: Delco 39, 42 Series (12V and 24V)..... 19-22

Section 7: DIESEL POWERED SERVICE TRUCKS

Replacement For: GM, Ford, Dodge Sprinter & Freightliner..... 23-24

Section 8: REFRIGERATED TRAILERS

Replacement For: Denso, Hitachi and Mitsubishi Units for Thermo King and Carrier Applications 25-26

Section 9: INTERCHANGE DATA.....

27-43

Section 10: TECHNICAL TIPS.....

44-49

Section 11: TECHNICAL DATA.....

50-53

REPLACEMENTS FOR:

DELCO 22 & 24 SERIES

ALT-1003 22 SERIES

VOLTAGE	AMPERAGE	MOUNTING
12V	150A	Pad Mount

APPLICATIONS

Various medium- & heavy-duty trucks, school & shuttle buses, including: Bluebird, Ford, Freightliner, GMC, Kenworth, Mack, Navistar, Peterbilt, Thomas, Volvo, Western Star, w/Caterpillar, Cummins & Detroit & Navistar Diesel engines.

Will replace 100, 130 & 145A models, please refer to Interchange Data



ALT-1004 22 SERIES

VOLTAGE	AMPERAGE	MOUNTING
12V	150A	Hinge Mount

APPLICATIONS

Various medium- & heavy-duty trucks, school & shuttle buses, including: Bluebird, Ford, Freightliner, GMC, Kenworth, Mack, Navistar, Peterbilt, Thomas, Volvo, Western Star, w/Caterpillar, Cummins & Detroit & Navistar Diesel engines.

Will replace 100, 130 & 145A models. Will replace Delco 21 models, please refer to Interchange Data

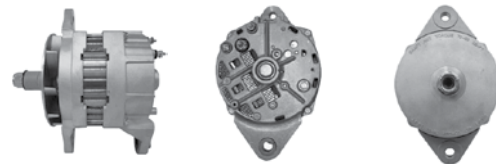

ALT-1240 24 SERIES

VOLTAGE	AMPERAGE	MOUNTING
12V	160A	Pad Mount

APPLICATIONS

Model Year 2005 and forward. Various medium- & heavy-duty trucks, school & shuttle buses, including: Bluebird, Ford, Freightliner, GMC, Kenworth, Mack, Navistar, Peterbilt, Thomas, Volvo, Western Star, w/Caterpillar, Cummins & Detroit, Mercedes & Navistar Diesel engines.

Will replace 130 & 145A models



ALT-1241 24 SERIES

VOLTAGE	AMPERAGE	MOUNTING
12V	160A	Hinge Mount

APPLICATIONS

Model Year 2005 and forward. Various medium- & heavy-duty trucks, school & shuttle buses, including: Bluebird, Ford, Freightliner, GMC, Kenworth, Mack, Navistar, Peterbilt, Thomas, Volvo, Western Star, w/Caterpillar, Cummins & Detroit, Mercedes & Navistar Diesel engines.

Will replace 100, 130 & 145A models

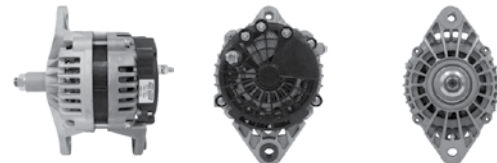

REPLACEMENTS FOR:

DELCO 28 SERIES

ALT-1280

VOLTAGE	AMPERAGE	MOUNTING
12V	200A	Pad Mount

APPLICATIONS

Model Year 2008 and forward. Various medium- & heavy-duty trucks, school & shuttle buses, including: Bluebird, Ford, Freightliner, GMC, Kenworth, Mack, Navistar, Peterbilt, Thomas, Volvo, Western Star, w/Caterpillar, Cummins & Detroit, Mercedes & Navistar Diesel engines.

Will replace various 180A models, as well as Delco 22 and 24 Series units for higher output performance. Please refer to Interchange Data.

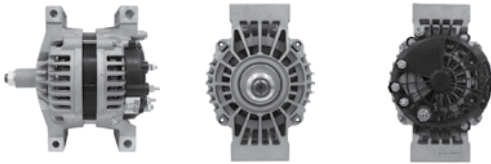

ALT-1281

VOLTAGE	AMPERAGE	MOUNTING
12V	200A	Hinge Mount

APPLICATIONS

Model Year 2008 and forward. Various medium- & heavy-duty trucks, school & shuttle buses, including: Bluebird, Ford, Freightliner, GMC, Kenworth, Mack, Navistar, Peterbilt, Thomas, Volvo, Western Star, w/Caterpillar, Cummins & Detroit, Mercedes & Navistar Diesel engines.

Will replace 22 & 24 Delco hinge mount units for higher output performance



ALT-1282

VOLTAGE	AMPERAGE	MOUNTING
12V	200A	Hinge Mount (Leece-Neville Type)

APPLICATIONS

Model Year 2008 and forward. Various medium- & heavy-duty trucks, school & shuttle buses, including: Bluebird, Ford, Freightliner, GMC, Kenworth, Mack, Navistar, Peterbilt, Thomas, Volvo, Western Star, w/Caterpillar, Cummins & Detroit, Mercedes & Navistar Diesel engines. w/Leece-Neville mount.

Will replace various 180A models, as well as Delco 22 and 24 Series units for higher output performance. Please refer to Interchange Data.



REPLACEMENTS FOR:

DELCO 33, 34, 35 & 36 BRUSHLESS SERIES

ALT-3632 33 SERIES

VOLTAGE	AMPERAGE	MOUNTING
12V	135A	Hinge Mount

APPLICATIONS

1996-03 Various medium- & heavy-duty trucks, including: Ford, Freightliner, GMC, Kenworth, Mack, Navistar, Peterbilt, Volvo, Western Star, w/Caterpillar, Cummins & Detroit & Navistar Diesel engines.

Will replace 110A models

Note: If alternator being replaced does not have remote sense 4th terminal, please ignore this terminal on replacement alternator

Can use : ALT-3602, ALT-3652

**ALT-3640** 34 SERIES

VOLTAGE	AMPERAGE	MOUNTING
12V	135A	Pad Mount

APPLICATIONS

2000-07 Various medium- & heavy-duty trucks, including: Ford, Freightliner, GMC, Kenworth, Mack, Navistar, Peterbilt, Volvo, Western Star, w/Caterpillar, Cummins & Detroit & Navistar Diesel engines.

Will replace 110A models

Note: If alternator being replaced does not have remote sense 4th terminal, please ignore this terminal on replacement alternator

Can use : ALT-3600, ALT-3650

**ALT-3641** 34 SERIES

VOLTAGE	AMPERAGE	MOUNTING
12V	135A	Quad Mount

APPLICATIONS

1997-03 Various medium- & heavy-duty trucks & school buses, including: Ford, Freightliner, GMC, Kenworth, Mack, Navistar, Peterbilt, Volvo, Western Star, w/Caterpillar, Cummins & Detroit & Navistar Diesel engines.

Will replace 110A models

Note: If alternator being replaced does not have remote sense 4th terminal, please ignore this terminal on replacement alternator

Can use : ALT-3601, ALT-3651



REPLACEMENTS FOR:

DELCO 33, 34, 35 & 36 BRUSHLESS SERIES

ALT-3650 35 SERIES

VOLTAGE	AMPERAGE	MOUNTING	REMOTE SENSE
12V	140A	Pad Mount	Yes

APPLICATIONS

2000-07 Various medium- & heavy-duty trucks, including: Ford, Freightliner, GMC, Kenworth, Mack, Navistar, Peterbilt, Volvo, Western Star, w/Caterpillar, Cummins & Detroit, Mercedes & Navistar Diesel engines.

Will replace 110, 135A models

Note: If alternator being replaced does not have remote sense 4th terminal, please ignore this terminal on replacement alternator

Can use : ALT-3600

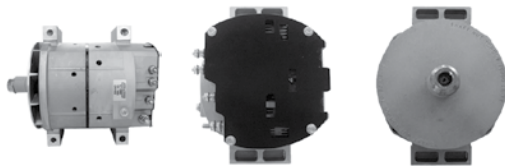

ALT-3651 35 SERIES

VOLTAGE	AMPERAGE	MOUNTING	REMOTE SENSE
12V	140A	Quad Mount	Yes

APPLICATIONS

1997-07 Various medium- & heavy-duty trucks & school buses, including: Ford, Freightliner, GMC, Kenworth, Mack, Navistar, Peterbilt, Volvo, Western Star, w/Caterpillar, Cummins & Detroit & Navistar Diesel engines.

Will replace 110, 135A models

Note: If alternator being replaced does not have remote sense 4th terminal, please ignore this terminal on replacement alternator

Can use : ALT-3601



ALT-3652 35 SERIES

VOLTAGE	AMPERAGE	MOUNTING	REMOTE SENSE
12V	140A	Hinge Mount	Yes

APPLICATIONS

1995-07 Various medium- & heavy-duty trucks & school buses, including: Ford, Freightliner, GMC, Kenworth, Mack, Navistar, Peterbilt, Volvo, Western Star, w/Caterpillar, Cummins & Detroit & Navistar Diesel engines.

Will replace 110, 135A models

Note: If alternator being replaced does not have remote sense 4th terminal, please ignore this terminal on replacement alternator

Can use : ALT-3602



ALT-3600 36 SERIES

VOLTAGE	AMPERAGE	MOUNTING	REMOTE SENSE
12V	170A	Pad Mount	Yes

APPLICATIONS

Model Year 2005 and forward. Various medium- & heavy-duty trucks, including: Ford, Freightliner, GMC, Kenworth, Mack, Navistar, Peterbilt, Volvo, Western Star, w/Caterpillar, Cummins & Detroit & Navistar Diesel engines.

Will replace 155, 160, 165A models

Note: If alternator being replaced does not have remote sense 4th terminal, please ignore this terminal on replacement alternator



ALT-3601 36 SERIES

VOLTAGE	AMPERAGE	MOUNTING	REMOTE SENSE
12V	170A	Quad Mount	Yes

APPLICATIONS

Model Year 2005 and forward. Various medium- & heavy-duty trucks, including: Ford, Freightliner, GMC, Kenworth, Mack, Navistar, Peterbilt, Volvo, Western Star, w/Caterpillar, Cummins & Detroit & Navistar Diesel engines.

Will replace 165A models

Note: If alternator being replaced does not have remote sense 4th terminal, please ignore this terminal on replacement alternator

Can use : ALT-3602



ALT-3602 36 SERIES

VOLTAGE	AMPERAGE	MOUNTING	REMOTE SENSE
12V	170A	Hinge Mount	Yes

APPLICATIONS

Model Year 2005 and forward. Various medium- & heavy-duty trucks, including: Ford, Freightliner, GMC, Kenworth, Mack, Navistar, Peterbilt, Volvo, Western Star, w/Caterpillar, Cummins & Detroit & Navistar Diesel engines.

Will replace 155, 165A models

Note: If alternator being replaced does not have remote sense 4th terminal, please ignore this terminal on replacement alternator



REPLACEMENTS FOR:

DELCO AD244 SERIES

ALT-1511

VOLTAGE	AMPERAGE	MOUNTING
12V	145A	w/6 groove serpentine pulley

APPLICATIONS

Model Year 2003 and forward. Medium-duty GMC trucks & school bus chassis w/8.1L gas engines.



REPLACEMENTS FOR:

PRESTOLITE (MOTOROLA) 110 SERIES

ALT-0050

VOLTAGE	AMPERAGE	MOUNTING
12V	160A	Hinge Mount

APPLICATIONS

Various medium- & heavy-duty trucks, school & shuttle buses, including: Bluebird, Ford, Freightliner, GMC, Kenworth, Mack, Navistar, Peterbilt, Thomas, Volvo, Western Star, w/Caterpillar, Cummins, Detroit, Mack, Navistar Diesel engines.

Will replace various Prestolite (Leece-Neville) models, please refer to Interchange Data.

Can use : ALT-0060, ALT-0070



ALT-0051

VOLTAGE	AMPERAGE	MOUNTING
12V	160A	Pad Mount

APPLICATIONS

Various medium- & heavy-duty trucks, school & shuttle buses, including: Bluebird, Ford, Freightliner, GMC, Kenworth, Mack, Navistar, Peterbilt, Thomas, Volvo, Western Star, w/Caterpillar, Cummins, Detroit, Mack, Navistar Diesel engines.

Can use : ALT-0061, ALT-0071



ALT-0060

VOLTAGE	AMPERAGE	MOUNTING
12V	165A	Hinge Mount

APPLICATIONS

Various medium- & heavy-duty trucks, school & shuttle buses, including: Bluebird, Ford, Freightliner, GMC, Kenworth, Mack, Navistar, Peterbilt, Thomas, Volvo, Western Star, w/Caterpillar, Cummins, Detroit, Mack, Navistar Diesel engines.

Can use : ALT-0070



ALT-0061

VOLTAGE	AMPERAGE	MOUNTING
12V	165A	Pad Mount

APPLICATIONS

Various medium- & heavy-duty trucks, school & shuttle buses, including: Bluebird, Ford, Freightliner, GMC, Kenworth, Mack, Navistar, Peterbilt, Thomas, Volvo, Western Star, w/Caterpillar, Cummins, Detroit, Mack, Navistar Diesel engines.

Can use : ALT-0071



ALT-0070

VOLTAGE	AMPERAGE	MOUNTING
12V	175A	Hinge Mount

APPLICATIONS

Various medium- & heavy-duty trucks, school & shuttle buses, including: Bluebird, Ford, Freightliner, GMC, Kenworth, Mack, Navistar, Peterbilt, Thomas, Volvo, Western Star, w/Caterpillar, Cummins, Detroit, Mack, Navistar Diesel engines.



ALT-0071

VOLTAGE	AMPERAGE	MOUNTING
12V	175A	Pad Mount

APPLICATIONS

Various medium- & heavy-duty trucks, school & shuttle buses, including: Bluebird, Ford, Freightliner, GMC, Kenworth, Mack, Navistar, Peterbilt, Thomas, Volvo, Western Star, w/Caterpillar, Cummins, Detroit, Mack, Navistar Diesel engines.



REPLACEMENTS FOR:

BOSCH T-1 SERIES

ALT-T141

VOLTAGE	AMPERAGE	MOUNTING
24V	140A	Threaded top front mounting hole, unthreaded bottom front & rear mounting holes

APPLICATIONS

Various coach & transit buses, including: Kassbohrer, MCI, Man, Mercedes, Prevost, Setra, Van Hool, Volvo & Others, w/Cummins, Detroit Diesel, Mercedes, Volvo & Other Engines, utilizing dual alternator system.

Will replace 95, 105 & 120A models

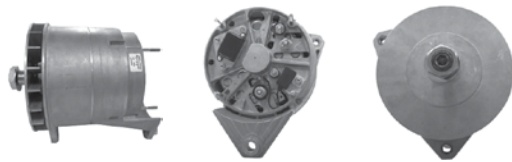

ALT-T145

VOLTAGE	AMPERAGE	MOUNTING
24V	140A	Threaded top front mounting hole, threaded bottom front & unthreaded bottom rear mounting holes

APPLICATIONS

Various coach & transit buses, including: Kassbohrer, MCI, Man, Mercedes, Prevost, Setra, Van Hool, Volvo & Others, w/Cummins, Detroit Diesel, Mercedes, Volvo & Other Engines, Utilizing Dual Alternator System.

Will replace 95, 105 & 120A models



ALT-T150

VOLTAGE	AMPERAGE	MOUNTING
24V	140A	Threaded top front mounting hole, threaded bottom front & unthreaded bottom rear mounting holes

APPLICATIONS

Various coach & transit buses, including: Kassbohrer, MCI, Man, Mercedes, Prevost, Setra, Van Hool, Volvo & Others, w/Cummins, Detroit Diesel, Mercedes, Volvo & Other Engines, Utilizing Dual Alternator System.

Will replace 105 & 120A models



REPLACEMENTS FOR:

DODGE SPRINTER & FREIGHTLINER

ALT-2300 KCB1 SERIES

VOLTAGE	AMPERAGE	MOUNTING
12V	130A	w/o pulley

APPLICATIONS

Model Year 2000 and forward. Dodge Sprinter & Freightliner medium-duty vans w/2.7L, 5 Cyl. Mercedes MBE600 Series Diesel engines.



ALT-2300U KCB1 SERIES

VOLTAGE	AMPERAGE	MOUNTING
12V	130A	w/clutch pulley

APPLICATIONS

Model Year 2000 and forward. Dodge Sprinter & Freightliner medium-duty vans w/2.7L, 5 Cyl. Mercedes MBE600 Series Diesel engines.



REPLACEMENTS FOR:

BOSCH UNITS

ALT-2235

VOLTAGE	AMPERAGE	MOUNTING
12V	37A	Standard

APPLICATIONS

Used on various Thermo King applications with various engines.

**ALT-2236**

VOLTAGE	AMPERAGE	MOUNTING
12V	90A	Standard

APPLICATIONS

Used on various Thermo King applications with various engines.

**ALT-2237**

VOLTAGE	AMPERAGE	MOUNTING
12V	120A	Standard

APPLICATIONS

Used on various Thermo King applications with various engines.



REPLACEMENTS FOR:

DELCO 28 SERIES GEAR REDUCTION

STR-7051

VOLTAGE	POWER	TOOTH COUNT
12V	2.5KW	10 Tooth

APPLICATIONS

1989-04 Various Freightliner, Kenworth & Sterling medium-duty trucks w/5.9L ISB Cummins engines.

Can use : STR-6052, STR-7005



STR-7054

VOLTAGE	POWER	TOOTH COUNT
12V	2.5KW	10 Tooth

APPLICATIONS

1998-03 Various Freightliner medium-duty trucks w/3.9L ISB Cummins engines.



STR-7055

VOLTAGE	POWER	TOOTH COUNT
12V	2.5KW	10 Tooth

APPLICATIONS

1989-00 Chevrolet & GMC medium & light-duty trucks & Vans w/6.2 & 6.5L Diesel engines.



STR-7056

VOLTAGE	POWER	TOOTH COUNT
12V	2.5KW	10 Tooth

APPLICATIONS

1992-99 Ford 600,700,800 & 900 Series medium-duty trucks & school buses, Bluebird school buses w/5.9L Cummins engines.



STR-7075

VOLTAGE	POWER	TOOTH COUNT
12V	2.5KW	10 Tooth

APPLICATIONS

1992-99 Ford 600,700,800 & 900 Series medium-duty trucks & school buses, Bluebird school buses w/5.9L Cummins Engines.



REPLACEMENTS FOR:

DELCO 29 SERIES PLANETARY GEAR REDUCTION

STR-0140

VOLTAGE	POWER	TOOTH COUNT
12V	3.3KW	10 Tooth

APPLICATIONS

Model Year 2002 and forward. Ford, Freightliner, Kenworth, Sterling medium-duty trucks w/5.9L ISB Cummins engines.

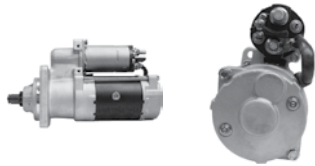

STR-0141

VOLTAGE	POWER	TOOTH COUNT
12V	3.3KW	9 Tooth

APPLICATIONS

Model Year 2002 and forward. Ford, Freightliner, Sterling medium-duty trucks, Bluebird & Thomas school buses w/OM904,906,924 Mercedes engines.



STR-0142

VOLTAGE	POWER	TOOTH COUNT
12V	3.3KW	10 Tooth

APPLICATIONS

Model Year 2002 and forward. Ford, Navistar medium-duty Trucks w/5.9L ISB Cummins engines.



STR-0143

VOLTAGE	POWER	TOOTH COUNT
12V	3.3KW	10 Tooth

APPLICATIONS

Model Year 2002 and forward. Ford, Freightliner, Sterling medium-duty trucks w/5.9L ISB Cummins engines.



STR-0144

VOLTAGE	POWER	TOOTH COUNT
12V	3.3KW	10 Tooth

APPLICATIONS

Model Year 2002 and forward. Navistar medium-duty trucks, Bluebird school buses w/VT-365 Navistar Engines.



REPLACEMENTS FOR:

DELCO 38 SERIES PLANETARY GEAR REDUCTION

STR-0120

VOLTAGE	TOOTH COUNT	NOTE
12V	10 Tooth	w/IMS Switch
APPLICATIONS		

Model Year 2003 and forward. Ford, Freightliner, Kenworth, Sterling medium-duty trucks, Bluebird & Thomas school buses w/8.3L Cummins, 3126 Caterpillar engines.



STR-0121

VOLTAGE	TOOTH COUNT	NOTE
12V	12 Tooth	w/IMS Switch
APPLICATIONS		

Model Year 2003 and forward. Freightliner, Peterbilt, Sterling medium-duty trucks w/8.3L Cummins, C-7 Caterpillar engines.



STR-0122

VOLTAGE	TOOTH COUNT	NOTE
12V	10 Tooth	w/IMS Switch
APPLICATIONS		

Model Year 2003 and forward. Ford, Navistar medium-duty trucks w/444 CI & T-444E Navistar engines.



STR-0123

VOLTAGE	TOOTH COUNT	NOTE
12V	11 Tooth	w/IMS Switch
APPLICATIONS		

Model Year 2003 and forward. Freightliner, Sterling medium-duty trucks, Bluebird school buses w/MBE900, OM926LA Series Mercedes engines.



STR-0124

VOLTAGE	TOOTH COUNT	NOTE
12V	10 Tooth	w/IMS Switch
APPLICATIONS		

Various Cummins JSB 3.9L, 4.5L, 5.9L, 6.7L Engines.



STR-0130

VOLTAGE	TOOTH COUNT	NOTE
24V	12 Tooth	w/IMS Switch
APPLICATIONS		

Model Year 2003 and forward. Various shuttle buses w/8.3L ISL Cummins Engines.

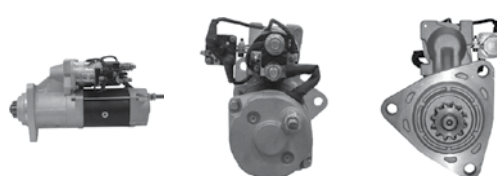

REPLACEMENTS FOR:

DELCO 38 SERIES PLANETARY GEAR REDUCTION

STR-0131

VOLTAGE	TOOTH COUNT	NOTE
24V	10 Tooth	w/IMS Switch

APPLICATIONS

Model Year 2003 and forward. Various shuttle buses w/8.3L ISL Cummins engines.



REPLACEMENTS FOR:

DELCO 39 SERIES PLANETARY GEAR REDUCTION

STR-4290

VOLTAGE	TOOTH COUNT	NOTE
12V	11 Tooth	w/IMS switch Rotateable D.E.** Hsg.

APPLICATIONS

Various heavy-duty trucks, including: Ford, Freightliner, Kenworth, Mack, Navistar, Peterbilt, Sterling, Volvo, Western Star, w/Caterpillar, Cummins, Detroit, Mack engines.

Can use : STR-4292



STR-4291

VOLTAGE	TOOTH COUNT	NOTE
12V	12 Tooth 43.5 mm Dia. Gear	IMS switch Rotateable D.E.** Hsg.

APPLICATIONS

Model Year 2001 and forward. Various Freightliner, Sterling heavy-duty trucks w/MBE4000 Mercedes engines.

Can use : STR-4293



STR-4292

VOLTAGE	TOOTH COUNT	NOTE
12V	11 Tooth	IMS switch OCP* Rotateable D.E.** Hsg.

APPLICATIONS

Various heavy-duty trucks, including: Ford, Freightliner, Kenworth, Mack, Navistar, Peterbilt, Sterling, Volvo, Western Star, w/Caterpillar, Cummins, Detroit, Mack engines.



STR-4293

VOLTAGE	TOOTH COUNT	NOTE
12V	12 Tooth 43.5 mm Dia. Gear	IMS switch OCP* Rotateable D.E.** Hsg.

APPLICATIONS

Model Year 2001 and forward. Various Freightliner, Sterling heavy-duty trucks w/MBE4000 Mercedes engines.



STR-4294

VOLTAGE	TOOTH COUNT	NOTE
12V	12 Tooth 46 mm Dia. Gear	IMS switch Rotateable D.E.** Hsg.

APPLICATIONS

Model Year 2001 and forward. Volvo heavy-duty trucks w/VE D12 Volvo engines.

Can use : STR-4295



STR-4295

VOLTAGE	TOOTH COUNT	NOTE
12V	12 Tooth 46 mm Dia. Gear	IMS switch OCP* Rotateable D.E.** Hsg.

APPLICATIONS

Model Year 2001 and forward. Volvo heavy-duty trucks w/VE D12 Volvo engines.



* Over Crank Protection (OCP)
** Rotating drive end housing (D.E.)

REPLACEMENTS FOR: DELCO 39 SERIES PLANETARY GEAR REDUCTION

STR-4390

VOLTAGE	TOOTH COUNT	NOTE
24V	11 Tooth	IMS switch Rotatable D.E.** Hsg.

APPLICATIONS

Model Year 2000 and forward. Various shuttle buses w/Caterpillar, Cummins & Detroit engines.

Can use : STR-4392



STR-4391

VOLTAGE	TOOTH COUNT	NOTE
24V	12 Tooth	IMS switch Rotatable D.E.** Hsg.

APPLICATIONS

Model Year 2000 and forward. Various coach & transit buses w/Cummins engines.

Can use : STR-4393



STR-4392

VOLTAGE	TOOTH COUNT	NOTE
24V	11 Tooth	IMS switch OCP* Rotatable D.E.** Hsg.

APPLICATIONS

Model Year 2000 and forward. Various shuttle buses w/Caterpillar, Cummins & Detroit engines.



STR-4393

VOLTAGE	TOOTH COUNT	NOTE
24V	12 Tooth	IMS switch OCP* Rotatable D.E.** Hsg.

APPLICATIONS

Model Year 2000 and forward. Various shuttle buses w/Cummins engines.



* Over Crank Protection (OCP)
** Rotating drive end housing (D.E.)
xpresswayplus.meritor.com

REPLACEMENTS FOR:

DELCO 42 SERIES DIRECT DRIVE

STR-4200

VOLTAGE	TOOTH COUNT
12V	11 Tooth

APPLICATIONS

Various heavy-duty trucks, including: Ford, Freightliner, Kenworth, Mack, Navistar, Peterbilt, Sterling, Volvo, Western Star, w/Caterpillar, Cummins, Detroit, Mack engines.

Will replace Delco 40 Series models, please refer to Interchange Data

Can use : STR-4201



STR-4201

VOLTAGE	TOOTH COUNT	NOTE
12V	11 Tooth	w/OCP*

APPLICATIONS

Various heavy-duty trucks, including: Ford, Freightliner, Kenworth, Mack, Navistar, Peterbilt, Sterling, Volvo, Western Star, w/Caterpillar, Cummins, Detroit, Mack engines.

Will replace Delco 40 Series models, please refer to Interchange Data



STR-4202

VOLTAGE	TOOTH COUNT
12V	12 Tooth

APPLICATIONS

Various heavy-duty trucks, including: Ford, Freightliner, Kenworth, Mack, Navistar, Peterbilt, Sterling, Volvo, Western Star, w/Caterpillar, Cummins, Detroit, Mack engines.

Will replace Delco 40 Series models, please refer to Interchange Data

Can use : STR-4206



STR-4206

VOLTAGE	TOOTH COUNT	NOTE
12V	12 Tooth	w/OCP*

APPLICATIONS

Various heavy-duty trucks, including: Ford, Freightliner, Kenworth, Mack, Navistar, Peterbilt, Sterling, Volvo, Western Star, w/Caterpillar, Cummins, Detroit, Mack engines.

Will replace Delco 40 Series models, please refer to Interchange Data



STR-4207

VOLTAGE	TOOTH COUNT
12V	11 Tooth

APPLICATIONS

Various heavy-duty trucks, including: Ford, Freightliner, Kenworth, Navistar, Peterbilt, Sterling Volvo, Western Star, w/Caterpillar, Cummins, Detroit engines.

Will replace Delco 40 Series models, please refer to Interchange Data

Note: Drive end housing angle opening configuration

Can use : STR-4208



STR-4208

VOLTAGE	TOOTH COUNT	NOTE
12V	11 Tooth	w/OCP*

APPLICATIONS

Various heavy-duty trucks, including: Ford, Freightliner, Kenworth, Navistar, Peterbilt, Sterling Volvo, Western Star, w/Caterpillar, Cummins, Detroit engines.

Will replace Delco 40 Series models, please refer to Interchange Data

Note: Drive end housing angle opening configuration



* Over Crank Protection (OCP)
 Contact Customer Care
 USA – 888-725-9355 CANADA – 800-387-3889

REPLACEMENTS FOR:

DELCO 42 SERIES DIRECT DRIVE

STR-4209

VOLTAGE	TOOTH COUNT	NOTE
12V	12 Tooth	Right Hand Mount

APPLICATIONS

Various heavy-duty trucks, including: Ford, Freightliner, Kenworth, Peterbilt, Sterling, Volvo, Western Star, White, w/3306, 3406 Caterpillar engines.



STR-4210

VOLTAGE	TOOTH COUNT	NOTE
12V	12 Tooth	w/OCP* Right Hand Mount

APPLICATIONS

Various heavy-duty trucks, including: Ford, Freightliner, Kenworth, Peterbilt, Sterling, Volvo, Western Star, White, w/3306, 3406 Caterpillar engines.



STR-4302

VOLTAGE	TOOTH COUNT
24V	11 Tooth

APPLICATIONS

Various heavy-duty trucks, including: Freightliner, Kenworth, Mack, Navistar, Peterbilt, Volvo, Western Star, w/Caterpillar, Cummins, Detroit, Mack engines.

Will replace Delco 40 Series models, please refer to Interchange Data

Can use : STR-4304



STR-4303

VOLTAGE	TOOTH COUNT
24V	12 Tooth

APPLICATIONS

Various heavy-duty trucks, including: Freightliner, Kenworth, Mack, Navistar, Peterbilt, Volvo, Western Star, w/Caterpillar, Cummins, Detroit, Mack engines.

Will replace Delco 40 Series models, please refer to Interchange Data

Can use : STR-4305



STR-4304

VOLTAGE	TOOTH COUNT	NOTE
24V	11 Tooth	w/OCP*

APPLICATIONS

Various heavy-duty trucks, including: Freightliner, Kenworth, Mack, Navistar, Peterbilt, Volvo, Western Star, w/Caterpillar, Cummins, Detroit, Mack engines.

Will replace Delco 40 Series models, please refer to Interchange Data



STR-4305

VOLTAGE	TOOTH COUNT	NOTE
24V	12 Tooth	w/OCP*

APPLICATIONS

Various heavy-duty trucks, including: Freightliner, Kenworth, Mack, Navistar, Peterbilt, Volvo, Western Star, w/Caterpillar, Cummins, Detroit, Mack engines.

Will replace Delco 40 Series models, please refer to Interchange Data



* Over Crank Protection (OCP)
xpresswayplus.meritor.com

REPLACEMENTS FOR: DELCO 39 SERIES PLANETARY GEAR REDUCTION

STR-4290

VOLTAGE	TOOTH COUNT	OTHER
12V	11 Tooth w/.66" Mtg. holes	w/IMS switch Rotatable D.E.** Hsg.

APPLICATIONS

Various coach and transit bus applications with Caterpillar, Cummins, Detroit diesel engines.

Can use : STR-4292



STR-4291

VOLTAGE	TOOTH COUNT	OTHER
12V	12 Tooth w/.53" Mtg. holes 43.5mm gear	IMS switch Rotatable D.E.** Hsg.

APPLICATIONS

Various coach and transit bus Applications with MBE4000 Mercedes engines.

Can use : STR-4293



STR-4292

VOLTAGE	TOOTH COUNT	OTHER
12V	11 Tooth w/.66" Mtg. holes	IMS switch OCP* Rotatable D.E.** Hsg.

APPLICATIONS

Various coach and transit bus applications with Caterpillar, Cummins, Detroit diesel engines.



STR-4293

VOLTAGE	TOOTH COUNT	OTHER
12V	12 Tooth w/.53" Mtg. holes 43.5mm gear	IMS switch OCP* Rotatable D.E.** Hsg.

APPLICATIONS

Various coach and transit bus Applications with MBE4000 Mercedes engines.



* Over Crank Protection (OCP)
 ** Rotating drive end housing (D.E.)
 Contact Customer Care
 USA – 888-725-9355 CANADA – 800-387-3889

REPLACEMENTS FOR:

DELCO 39 SERIES PLANETARY GEAR REDUCTION

STR-4390

VOLTAGE	TOOTH COUNT	OTHER
24V	11 Tooth w/.66" Mtg. holes	IMS switch Rotatable D.E.** Hsg.

APPLICATIONS

MCI and other coach and transit bus applications with Caterpillar, Cummins & Detroit Diesel engines.

Can Use : STR-4392



STR-4391

VOLTAGE	TOOTH COUNT	OTHER
24V	12 Tooth w/.53" Mtg. holes	IMS switch Rotatable D.E.** Hsg.

APPLICATIONS

Various coach and transit bus applications with Cummins engines.

Can Use : STR-4393



STR-4392

VOLTAGE	TOOTH COUNT	OTHER
24V	11 Tooth w/.66" Mtg. holes	IMS switch OCP* Rotatable D.E.** Hsg.

APPLICATIONS

MCI and other coach and transit bus applications with Caterpillar, Cummins & Detroit Diesel engines.



STR-4393

VOLTAGE	TOOTH COUNT	OTHER
24V	12 Tooth w/.53" Mtg. holes	IMS switch OCP* Rotatable D.E.** Hsg.

APPLICATIONS

Various coach and transit bus applications with Cummins engines.



* Over Crank Protection (OCP)
** Rotating drive end housing (D.E.)
xpresswayplus.meritor.com

REPLACEMENTS FOR:

DELCO 42 SERIES DIRECT DRIVE

STR-4200

VOLTAGE	TOOTH COUNT
12V	11 Tooth

APPLICATIONS

Various coach and transit buses with Caterpillar, Cummins, Detroit Diesel engines.

Will replace Delco 40 Series models, please refer to Interchange Data

Can use : STR-4201



STR-4201

VOLTAGE	TOOTH COUNT	OTHER
12V	11 Tooth	w/OCP*

APPLICATIONS

Various coach and transit buses with Caterpillar, Cummins, Detroit Diesel engines.

Will replace Delco 40 Series models, please refer to Interchange Data



* Over Crank Protection (OCP)
 Contact Customer Care
 USA – 888-725-9355 CANADA – 800-387-3889

REPLACEMENTS FOR:

DELCO 42 SERIES DIRECT DRIVE

STR-4302

VOLTAGE	TOOTH COUNT
24V	11 Tooth

APPLICATIONS

Various coach and transit buses with Caterpillar, Cummins, Detroit Diesel engines.

Will replace Delco 40 Series models, please refer to Interchange Data

Can use : STR-4304



STR-4303

VOLTAGE	TOOTH COUNT
24V	12 Tooth

APPLICATIONS

Various coach and transit buses with Caterpillar, Cummins, Detroit Diesel engines.

Will replace Delco 40 Series models, please refer to Interchange Data

Can use : STR-4305



STR-4304

VOLTAGE	TOOTH COUNT	OTHER
24V	11 Tooth	w/OCP*

APPLICATIONS

Various coach and transit buses with Caterpillar, Cummins, Detroit Diesel engines.

Will replace Delco 40 Series models, please refer to Interchange Data



STR-4305

VOLTAGE	TOOTH COUNT	OTHER
24V	12 Tooth	w/OCP*

APPLICATIONS

Various coach and transit buses with Caterpillar, Cummins, Detroit Diesel engines.

Will replace Delco 40 Series models, please refer to Interchange Data



* Over Crank Protection (OCP)
xpresswayplus.meritor.com

REPLACEMENTS FOR:

GM, FORD, DODGE SPRINTER & FREIGHTLINER

STR-2210

VOLTAGE	KW	TOOTH COUNT
---------	----	-------------

12V	2.2KW	10 Tooth
-----	-------	----------

APPLICATIONS

Model Year 1999 and forward. Dodge Sprinter and Freightliner with Mercedes-Benz engines.



STR-6052 Gear Reduction

VOLTAGE	KW	TOOTH COUNT
---------	----	-------------

12V	2.5KW	13 Tooth
-----	-------	----------

APPLICATIONS

1985-94 Ford medium- & light-duty trucks & vans w/6.9, 7.3L Diesel engines.

Can use : STR-7005, STR-7051



STR-6090 Gear Reduction

VOLTAGE	KW	TOOTH COUNT
---------	----	-------------

12V	2.5KW	13 Tooth Wet Clutch
-----	-------	------------------------

APPLICATIONS

Model Year 1994 and forward. Ford, Freightliner, Kenworth, Navistar, Sterling medium-duty trucks, Bluebird buses w/5.9L Cummins engines.



STR-7006 Gear Reduction

VOLTAGE	KW	TOOTH COUNT	OTHER
---------	----	-------------	-------

12V	2.5KW	12 Tooth	Late model
-----	-------	----------	------------

APPLICATIONS

Model Year 1994 and forward. Ford medium & light-duty trucks & vans w/7.3L Powerstroke Diesel engines.



STR-7010 Gear Reduction

VOLTAGE	KW	TOOTH COUNT
---------	----	-------------

12V	3.6KW	9 Tooth
-----	-------	---------

APPLICATIONS

Model Year 1999 and forward. Various Mitsubishi Fuso medium-duty trucks w/4D34 Mitsubishi engines.



STR-7012 Gear Reduction

VOLTAGE	KW	TOOTH COUNT
---------	----	-------------

12V	3.6KW	12 Tooth
-----	-------	----------

APPLICATIONS

Model Year 2001 and forward. Ford medium- & light-duty trucks & vans with 6.0L & 7.3L Diesel engines.



REPLACEMENTS FOR:

GM, FORD, DODGE SPRINTER & FREIGHTLINER

STR-7013

VOLTAGE	KW	TOOTH COUNT
12V	3.6KW	12 Tooth

APPLICATIONS

Model Year 2003 and 2004. Ford medium- & light-duty trucks & vans with 6.0L Diesel engines.



STR-9050 Gear Reduction

VOLTAGE	KW	TOOTH COUNT
12V	4.0KW	10 Tooth

APPLICATIONS

Model Year 1996 and forward. Chevrolet/GMC, Ford, Freightliner, Kenworth, Ottawa, Western Star, Bluebird & Thomas school & shuttle buses w/3116, 3126 Caterpillar engines.



STR-9051 Gear Reduction

VOLTAGE	KW	TOOTH COUNT
12V	4.0KW	10 Tooth

APPLICATIONS

Model Year 1995 and forward. Navistar & Volvo medium-duty trucks, Bluebird, Thomas school & shuttle buses w/8.3L Cummins, DT-466 Navistar, VE D12 Volvo engines.

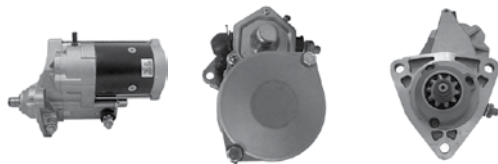

REPLACEMENTS FOR:

DENSO, HITACHI AND MITSUBISHI UNITS

STR-3571 Mitsubishi

VOLTAGE	KW	TOOTH COUNT
12V	1.2KW	9 Tooth Direct Drive Mitsubishi Type

APPLICATIONS

Used on various Carrier applications with Kubota engines.



STR-5001 Denso

VOLTAGE	KW	TOOTH COUNT
12V	2.0KW	9 Tooth Gear Reduction

APPLICATIONS

Used on various Thermo King applications with Isuzu engines.



STR-5021 Denso

VOLTAGE	KW	TOOTH COUNT
12V	2.0KW	9 Tooth Gear Reduction

APPLICATIONS

Used on various Carrier applications with Kubota engines.



STR-5300 Denso

VOLTAGE	KW	TOOTH COUNT
12V	2.2KW	9 Tooth

APPLICATIONS

Used on various Carrier applications with Kubota engines.



STR-6001 Hitachi

VOLTAGE	KW	TOOTH COUNT
12V	2.0KW	9 Tooth Gear Reduction

APPLICATIONS

Used on various Thermo King applications with Isuzu engines.



STR-6006 Hitachi

VOLTAGE	KW	TOOTH COUNT
12V	2.0KW	9 Tooth Gear Reduction

APPLICATIONS

Used on various Thermo King applications with Isuzu engines.



REPLACEMENTS FOR:

REFRIGERATED TRAILERS

STR-6009 Hitachi

VOLTAGE	KW	TOOTH COUNT
12V	2.0KW	9 Tooth Gear Reduction

APPLICATIONS

Used on various Thermo King applications with TK486 engines.



STR-8057 Denso

VOLTAGE	KW	TOOTH COUNT
12V	1.4KW	11 Tooth Gear Reduction

APPLICATIONS

Used on various Carrier applications with Kubota engines.



STR-8112

VOLTAGE	KW	TOOTH COUNT
12V	1.4KW	15 Tooth

APPLICATIONS

Used on various Thermo King and Carrier applications with Yanmar engines.



INTERCHANGE DATA

Manufacturer	OEM Part #	Meritor	Manufacturer	OEM Part #	Meritor	Manufacturer	OEM Part #	Meritor
BLUEBIRD	73358	ALT-T141	BOSCH	0-120-689-513	ALT-T145	BOSCH	SR597X [4]	STR-7051
BLUEBIRD	1454651	STR-9050	BOSCH	0-120-689-515	ALT-T145	BOSCH	SR615X [4]	STR-7055
BLUEBIRD	1935477	STR-9051	BOSCH	0-120-689-517	ALT-T150	BOSCH	SR7529N	STR-7006
BLUEBIRD	8314056	ALT-0060	BOSCH	0-120-689-522	ALT-T150	BOSCH	SR7529X	STR-7006
BLUEBIRD	0045863 [12]	ALT-0050	BOSCH	0-120-689-527	ALT-T150	BOSCH	SR7563X	STR-7005
BLUEBIRD	0046864 [12]	ALT-0060	BOSCH	0-120-689-532	ALT-T145	BOSCH	SR7582X	STR-7012
BLUEBIRD	0046875 [12]	ALT-0060	BOSCH	0-120-689-533	ALT-T145	BOSCH	SR8574N	STR-7055
BLUEBIRD	0046882 [12]	ALT-0060	BOSCH	0-120-689-535	ALT-T145	BOSCH	SR8574X	STR-7055
BLUEBIRD	0048138 [12]	ALT-0050	BOSCH	0-120-689-540	ALT-T150	BOSCH	SR901X [4]	STR-7072
BLUEBIRD	0048139 [12]	ALT-0060	BOSCH	0-120-689-541	ALT-T150	BOSCH	SR950X [17]	STR-4302
BLUEBIRD	0048140 [12]	ALT-0060	BOSCH	0-120-689-552	ALT-T141	BOSCH	SR950X [8]	STR-4302
BLUEBIRD	0067536 [12]	ALT-0070	BOSCH	0-120-689-566	ALT-T141	BOSCH	SR954X	STR-4250
BLUEBIRD	0102485 [5]	ALT-1282	BOSCH	0-120-689-569	ALT-T150	BOSCH	SR955X [8]	STR-4202
BLUEBIRD	0102486 [5]	ALT-1282	BOSCH	0-124-325-039	ALT-2300U	BOSCH	SR956X	STR-4200
BLUEBIRD	0103210 [5]	ALT-1280	BOSCH	0-124-325-093	ALT-2300U	BOSCH	SR957X	STR-4302
BLUEBIRD	1144203 [12]	ALT-0060	BOSCH	0-124-515-064	ALT-2300U	BOSCH	SR961X [17]	STR-4200
BOSCH	9-000-330-934	STR-3571	BOSCH	0-124-525-085 [3]	ALT-1241	BOSCH	SR961X [8]	STR-4200
BOSCH	0-001-109-250 [1]	STR-2050	BOSCH	0-124-525-109 [3]	ALT-1240	BOSCH	SR963X	STR-4303
BOSCH	0-001-218-006	STR-2050	BOSCH	0-124-555-001	ALT-2110	BOSCH	SR9936X	STR-2380
BOSCH	0-001-218-021	STR-2050	BOSCH	0-124-555-002	ALT-2110	BOSCH	SR9938X	STR-7051
BOSCH	0-001-218-108	STR-2050	BOSCH	0-124-555-004	ALT-2110	BOSCH	SR9943X	STR-6052
BOSCH	0-001-218-150	STR-2050	BOSCH	0-124-555-009	ALT-2117A	BOSCH	SR9948X	STR-6090
BOSCH	0-001-218-156	STR-2050	BOSCH	0-124-555-017	ALT-2117A	BOSCH	SR9973X	STR-7051
BOSCH	0-001-223-005 [1]	STR-2050	BOSCH	0-124-555-017	ALT-2117B	CATERPILLAR	002-5900 [17]	STR-4303
BOSCH	0-001-410-046	STR-2381	BOSCH	0-124-555-020	ALT-2117A	CATERPILLAR	002-5900 [8]	STR-4303
BOSCH	0-001-411-009	STR-2391	BOSCH	0-124-555-022	ALT-2110	CATERPILLAR	0R1522 [2]	ALT-1004
BOSCH	0-001-415-001	STR-2380	BOSCH	0-124-555-027	ALT-2117A	CATERPILLAR	0R2186	STR-4303
BOSCH	0-001-416-002	STR-2380	BOSCH	0-124-555-028	ALT-2117A	CATERPILLAR	0R2187	STR-4302
BOSCH	0-001-416-005	STR-2381	BOSCH	0-124-625-043 [5]	ALT-1280	CATERPILLAR	0R2189	STR-4202
BOSCH	0-001-416-007	STR-2381	BOSCH	0-124-655-001	ALT-2111	CATERPILLAR	0R2190	STR-4302
BOSCH	0-001-417-001	STR-2391	BOSCH	0-124-655-002	ALT-2111	CATERPILLAR	0R2191	STR-4200
BOSCH	0-001-417-053	STR-2394	BOSCH	0-124-655-003	ALT-2111	CATERPILLAR	0R3527 [2]	ALT-1004
BOSCH	0-001-420-002 [17]	STR-4302	BOSCH	0-124-655-004	ALT-2111	CATERPILLAR	0R3652	ALT-0108
BOSCH	0-001-420-002 [8]	STR-4302	BOSCH	0-124-655-008	ALT-2117A	CATERPILLAR	0R4256	STR-4303
BOSCH	0-001-420-003 [17]	STR-4303	BOSCH	0-124-655-012	ALT-2117B	CATERPILLAR	0R4257	STR-4303
BOSCH	0-001-420-003 [8]	STR-4303	BOSCH	0-124-655-019	ALT-2117B	CATERPILLAR	0R4259	STR-4302
BOSCH	0-001-420-004 [17]	STR-4303	BOSCH	0-986-039-260	ALT-0113	CATERPILLAR	0R4260 [8]	STR-4202
BOSCH	0-001-420-004 [8]	STR-4303	BOSCH	0-986-039-490	ALT-0104	CATERPILLAR	0R4265 [8]	STR-4202
BOSCH	0-001-420-005 [17]	STR-4303	BOSCH	0-986-042-360	ALT-2110	CATERPILLAR	0R4272	STR-4250
BOSCH	0-001-420-005 [8]	STR-4303	BOSCH	0-986-042-370	ALT-2110	CATERPILLAR	0R5202 [2]	ALT-1004
BOSCH	0-001-420-006 [17]	STR-4302	BOSCH	0-986-042-390	ALT-2111	CATERPILLAR	0R5207 [17]	STR-4303
BOSCH	0-001-420-006 [8]	STR-4302	BOSCH	0-986-042-400	ALT-2111	CATERPILLAR	0R5207 [8]	STR-4303
BOSCH	0-001-420-008 [17]	STR-4302	BOSCH	0-986-042-530	ALT-2300U	CATERPILLAR	0R5208 [8]	STR-4202
BOSCH	0-001-420-008 [8]	STR-4302	BOSCH	0-986-042-850	ALT-T150	CATERPILLAR	0R5209 [17]	STR-4302
BOSCH	0-001-420-010 [17]	STR-4302	BOSCH	0-986-043-900	ALT-2300U	CATERPILLAR	0R5209 [8]	STR-4302
BOSCH	0-001-420-010 [8]	STR-4302	BOSCH	1-120-468-144	ALT-0113	CATERPILLAR	0R5213	STR-4250
BOSCH	0-001-420-013 [17]	STR-4303	BOSCH	1-124-625-044 [5]	ALT-1281	CATERPILLAR	0R5214	STR-4251
BOSCH	0-001-420-013 [8]	STR-4303	BOSCH	6-033-G30-57B	ALT-0104	CATERPILLAR	0R5216 [8]	STR-4202
BOSCH	0-120-468-053	ALT-0102	BOSCH	6-033-G30-60B	ALT-0104	CATERPILLAR	0R5218	STR-4202
BOSCH	0-120-468-107	ALT-0102	BOSCH	6-033-GB3-023	ALT-0114	CATERPILLAR	0R5270 [17]	STR-4303
BOSCH	0-120-468-131	ALT-0104	BOSCH	6-033-GB3-033	ALT-0104	CATERPILLAR	0R5270 [8]	STR-4303
BOSCH	0-120-468-135	ALT-0113	BOSCH	6-033-GB3-034	ALT-0104	CATERPILLAR	0R5347 [17]	STR-4200
BOSCH	0-120-468-143	ALT-0114	BOSCH	0-986-011-881	STR-3571	CATERPILLAR	0R5347 [8]	STR-4200
BOSCH	0-120-468-145	ALT-0114	BOSCH	AL0791N	ALT-2300U	CATERPILLAR	104-7041	STR-4302
BOSCH	0-120-469-001	ALT-0110	BOSCH	AL0791X	ALT-2300U	CATERPILLAR	104-7042	STR-4302
BOSCH	0-120-469-014	ALT-0106	BOSCH	AL0798N	ALT-2300U	CATERPILLAR	106-8551	STR-4302
BOSCH	0-120-469-523	ALT-0106	BOSCH	AL0798X	ALT-2300U	CATERPILLAR	106-8552	STR-4303
BOSCH	0-120-469-569	ALT-0108	BOSCH	AL0801N	ALT-2300U	CATERPILLAR	106-8554	STR-4302
BOSCH	0-120-469-643	ALT-0108	BOSCH	AL0801X	ALT-2300U	CATERPILLAR	106-8555	STR-4303
BOSCH	0-120-469-686	ALT-0110	BOSCH	AL8515X	ALT-1511	CATERPILLAR	1214134 [2]	ALT-1004
BOSCH	0-120-469-763	ALT-0108	BOSCH	AL952X [2]	ALT-1004	CATERPILLAR	1P7837 [17]	STR-4303
BOSCH	0-120-469-798	ALT-0106	BOSCH	AL9938X	ALT-0108	CATERPILLAR	1P7837 [8]	STR-4303
BOSCH	0-120-469-807	ALT-0108	BOSCH	AL9960LH [3]	ALT-1241	CATERPILLAR	1P7838 [17]	STR-4303
BOSCH	0-120-469-900	ALT-0108	BOSCH	AL9961LH [3]	ALT-1240	CATERPILLAR	1P7838 [8]	STR-4303
BOSCH	0-120-469-959	ALT-0108	BOSCH	AL9962SB [5]	ALT-1280	CATERPILLAR	1P7839 [17]	STR-4303
BOSCH	0-120-469-960	ALT-0108	BOSCH	AL9963SB [5]	ALT-1281	CATERPILLAR	1P7839 [8]	STR-4303
BOSCH	0-120-469-982	ALT-0110	BOSCH	SR0465X [1]	STR-2050	CATERPILLAR	1P9162	STR-4251
BOSCH	0-120-689-503	ALT-T145	BOSCH	SR0473N [1]	STR-2050	CATERPILLAR	1P9182	STR-4251
BOSCH	0-120-689-504	ALT-T150	BOSCH	SR0473X [1]	STR-2050	CATERPILLAR	207-1523	STR-4209
BOSCH	0-120-689-507	ALT-T150	BOSCH	SR47X	STR-2050	CATERPILLAR	2N2761	STR-4200
BOSCH	0-120-689-508	ALT-T145	BOSCH	SR577X [4]	STR-7055	CATERPILLAR	2N3538 [8]	STR-4202
BOSCH	0-120-689-512	ALT-T145	BOSCH	SR587X [11]	STR-7005	CATERPILLAR	2P6162 [17]	STR-4303

*See page 43 for all footnotes

INTERCHANGE DATA

Manufacturer	OEM Part #	Meritor	Manufacturer	OEM Part #	Meritor	Manufacturer	OEM Part #	Meritor
CATERPILLAR	2P6162 [8]	STR-4303	CATERPILLAR	4N0956 [8]	STR-4200	CATERPILLAR	6N9667	STR-4250
CATERPILLAR	2S0900 [17]	STR-4303	CATERPILLAR	4N0957	STR-4302	CATERPILLAR	6N9677	STR-4250
CATERPILLAR	2S0900 [8]	STR-4303	CATERPILLAR	4N0959	STR-4250	CATERPILLAR	6T0640	STR-4250
CATERPILLAR	2S900 [17]	STR-4303	CATERPILLAR	4N1062	STR-4302	CATERPILLAR	6T0647	STR-4250
CATERPILLAR	2S900 [8]	STR-4303	CATERPILLAR	4N1064 [17]	STR-4200	CATERPILLAR	6V0511	STR-4250
CATERPILLAR	2T0797 [17]	STR-4302	CATERPILLAR	4N1064 [8]	STR-4200	CATERPILLAR	6V0590	STR-4250
CATERPILLAR	2T0797 [8]	STR-4302	CATERPILLAR	4N3181 [17]	STR-4303	CATERPILLAR	6V0890	STR-4250
CATERPILLAR	3E7863	STR-4207	CATERPILLAR	4N3181 [8]	STR-4303	CATERPILLAR	6V3948 [8]	STR-4202
CATERPILLAR	3E7864 [8]	STR-4202	CATERPILLAR	4N3182 [17]	STR-4303	CATERPILLAR	6V3954 [8]	STR-4202
CATERPILLAR	3L8205	STR-4250	CATERPILLAR	4N3182 [8]	STR-4303	CATERPILLAR	6V4214	STR-4209
CATERPILLAR	3P0007 [17]	STR-4303	CATERPILLAR	4N3343	STR-4250	CATERPILLAR	6V5207	STR-4303
CATERPILLAR	3P0007 [8]	STR-4303	CATERPILLAR	4N3347 [17]	STR-4303	CATERPILLAR	6V5226	STR-4303
CATERPILLAR	3P0110 [8]	STR-4202	CATERPILLAR	4N3347 [8]	STR-4303	CATERPILLAR	6V5227	STR-4303
CATERPILLAR	3R2657 [8]	STR-4202	CATERPILLAR	4N3348 [17]	STR-4303	CATERPILLAR	6V5537	STR-4303
CATERPILLAR	3R7356 [17]	STR-4303	CATERPILLAR	4N3348 [8]	STR-4303	CATERPILLAR	6V5539	STR-4302
CATERPILLAR	3R7356 [8]	STR-4303	CATERPILLAR	4N3349	STR-4250	CATERPILLAR	6V6707	STR-4303
CATERPILLAR	3R9282 [17]	STR-4303	CATERPILLAR	4N3350 [17]	STR-4303	CATERPILLAR	7L8797 [17]	STR-4302
CATERPILLAR	3R9282 [8]	STR-4303	CATERPILLAR	4N3350 [8]	STR-4303	CATERPILLAR	7L8797 [8]	STR-4302
CATERPILLAR	3S4458	STR-4251	CATERPILLAR	4N7752 [17]	STR-4303	CATERPILLAR	7N6503 [8]	STR-4202
CATERPILLAR	3T2579	STR-4303	CATERPILLAR	4N7752 [8]	STR-4303	CATERPILLAR	7N8604	STR-4251
CATERPILLAR	3T2646 [17]	STR-4302	CATERPILLAR	4N7903 [17]	STR-4303	CATERPILLAR	7S2234 [17]	STR-4303
CATERPILLAR	3T2646 [8]	STR-4302	CATERPILLAR	4N7903 [8]	STR-4303	CATERPILLAR	7S2234 [8]	STR-4303
CATERPILLAR	3T2647 [17]	STR-4303	CATERPILLAR	4N7904 [17]	STR-4303	CATERPILLAR	7S3622 [17]	STR-4303
CATERPILLAR	3T2647 [8]	STR-4303	CATERPILLAR	4N7904 [8]	STR-4303	CATERPILLAR	7S3622 [8]	STR-4303
CATERPILLAR	3T2649 [17]	STR-4302	CATERPILLAR	4N7905 [17]	STR-4303	CATERPILLAR	7T0794 [17]	STR-4302
CATERPILLAR	3T2649 [8]	STR-4302	CATERPILLAR	4N7905 [8]	STR-4303	CATERPILLAR	7T0794 [8]	STR-4302
CATERPILLAR	3T2650 [17]	STR-4302	CATERPILLAR	4N8118 [17]	STR-4302	CATERPILLAR	7T0798 [17]	STR-4303
CATERPILLAR	3T2650 [8]	STR-4302	CATERPILLAR	4N8118 [8]	STR-4302	CATERPILLAR	7T0798 [8]	STR-4303
CATERPILLAR	3T2652	STR-4303	CATERPILLAR	4N8253 [8]	STR-4202	CATERPILLAR	7T0799 [17]	STR-4303
CATERPILLAR	3T2654 [17]	STR-4200	CATERPILLAR	4N956 [17]	STR-4200	CATERPILLAR	7T0799 [8]	STR-4303
CATERPILLAR	3T2654 [8]	STR-4200	CATERPILLAR	4N956 [8]	STR-4200	CATERPILLAR	7T0800 [17]	STR-4302
CATERPILLAR	3T2655 [8]	STR-4202	CATERPILLAR	4N957 [17]	STR-4302	CATERPILLAR	7T0800 [8]	STR-4302
CATERPILLAR	3T2657 [8]	STR-4202	CATERPILLAR	4N957 [8]	STR-4302	CATERPILLAR	7T0801 [17]	STR-4302
CATERPILLAR	3T2660 [17]	STR-4303	CATERPILLAR	5A6494 [17]	STR-4303	CATERPILLAR	7T0801 [8]	STR-4302
CATERPILLAR	3T2660 [8]	STR-4303	CATERPILLAR	5A6494 [8]	STR-4303	CATERPILLAR	7T0806 [17]	STR-4302
CATERPILLAR	3T2772 [17]	STR-4303	CATERPILLAR	5A6495 [17]	STR-4303	CATERPILLAR	7T0806 [8]	STR-4302
CATERPILLAR	3T2772 [8]	STR-4303	CATERPILLAR	5A6495 [8]	STR-4303	CATERPILLAR	7T1081 [8]	STR-4202
CATERPILLAR	3T2780	STR-4250	CATERPILLAR	5A6522 [17]	STR-4303	CATERPILLAR	7T1082 [17]	STR-4303
CATERPILLAR	3T2781	STR-4251	CATERPILLAR	5A6522 [8]	STR-4303	CATERPILLAR	7T1082 [8]	STR-4303
CATERPILLAR	3T2785	STR-4250	CATERPILLAR	5L2537 [17]	STR-4302	CATERPILLAR	7T1799 [17]	STR-4303
CATERPILLAR	3T2787	STR-4250	CATERPILLAR	5L2537 [8]	STR-4302	CATERPILLAR	7T1799 [8]	STR-4303
CATERPILLAR	3T2879 [17]	STR-4200	CATERPILLAR	5L2637 [17]	STR-4302	CATERPILLAR	7T2265 [8]	STR-4202
CATERPILLAR	3T2879 [8]	STR-4200	CATERPILLAR	5L2637 [8]	STR-4302	CATERPILLAR	7T9254 [8]	STR-4202
CATERPILLAR	3T3152 [17]	STR-4302	CATERPILLAR	5L4160 [17]	STR-4200	CATERPILLAR	7T9255 [8]	STR-4202
CATERPILLAR	3T3152 [8]	STR-4302	CATERPILLAR	5L4160 [8]	STR-4200	CATERPILLAR	8C359 [8]	STR-4202
CATERPILLAR	3T3153 [17]	STR-4302	CATERPILLAR	5L4168 [17]	STR-4200	CATERPILLAR	8C3592 [17]	STR-4200
CATERPILLAR	3T3153 [8]	STR-4302	CATERPILLAR	5L4168 [8]	STR-4200	CATERPILLAR	8C3592 [8]	STR-4200
CATERPILLAR	3T3154 [17]	STR-4200	CATERPILLAR	5L4169 [17]	STR-4200	CATERPILLAR	8C3593 [17]	STR-4200
CATERPILLAR	3T3154 [8]	STR-4200	CATERPILLAR	5L4169 [8]	STR-4200	CATERPILLAR	8C3593 [8]	STR-4200
CATERPILLAR	3T3430	STR-4251	CATERPILLAR	5L4405	STR-4250	CATERPILLAR	8C3596	STR-4202
CATERPILLAR	3T3778	STR-4250	CATERPILLAR	5L5353	STR-4250	CATERPILLAR	8C3597 [17]	STR-4303
CATERPILLAR	3T4581 [17]	STR-4303	CATERPILLAR	5L537 [17]	STR-4302	CATERPILLAR	8C3597 [8]	STR-4303
CATERPILLAR	3T4581 [8]	STR-4303	CATERPILLAR	5L537 [8]	STR-4302	CATERPILLAR	8C3643 [8]	STR-4202
CATERPILLAR	3T4582 [17]	STR-4303	CATERPILLAR	5L5667 [17]	STR-4200	CATERPILLAR	8C3644 [17]	STR-4302
CATERPILLAR	3T4582 [8]	STR-4303	CATERPILLAR	5L5667 [8]	STR-4200	CATERPILLAR	8C3644 [8]	STR-4302
CATERPILLAR	3T4584 [17]	STR-4303	CATERPILLAR	5L5867 [17]	STR-4200	CATERPILLAR	8C3645	STR-4302
CATERPILLAR	3T4584 [8]	STR-4303	CATERPILLAR	5L5867 [8]	STR-4200	CATERPILLAR	8C3647 [17]	STR-4303
CATERPILLAR	3T4586 [17]	STR-4303	CATERPILLAR	5L637 [17]	STR-4302	CATERPILLAR	8C3647 [8]	STR-4303
CATERPILLAR	3T4586 [8]	STR-4303	CATERPILLAR	5L637 [8]	STR-4302	CATERPILLAR	8C3648 [8]	STR-4202
CATERPILLAR	3T6305 [17]	STR-4303	CATERPILLAR	5L648	STR-4250	CATERPILLAR	8C3649 [17]	STR-4302
CATERPILLAR	3T6305 [8]	STR-4303	CATERPILLAR	5N2685	STR-4250	CATERPILLAR	8C3649 [8]	STR-4302
CATERPILLAR	3T7070 [2]	ALT-1004	CATERPILLAR	5R3155 [17]	STR-4303	CATERPILLAR	8C3650 [17]	STR-4303
CATERPILLAR	3T8947	STR-4250	CATERPILLAR	5R3155 [8]	STR-4303	CATERPILLAR	8C3650 [8]	STR-4303
CATERPILLAR	3T8949	STR-4250	CATERPILLAR	5R3857 [17]	STR-4303	CATERPILLAR	8C3651	STR-4303
CATERPILLAR	3T8950	STR-4251	CATERPILLAR	5R3857 [8]	STR-4303	CATERPILLAR	8C3652	STR-4200
CATERPILLAR	3T8954	STR-4250	CATERPILLAR	6N1888 [17]	STR-4302	CATERPILLAR	8H1813 [17]	STR-4302
CATERPILLAR	3T8967	STR-4250	CATERPILLAR	6N1888 [8]	STR-4302	CATERPILLAR	8H1813 [8]	STR-4302
CATERPILLAR	3Y8852 [17]	STR-4303	CATERPILLAR	6N1889	STR-4302	CATERPILLAR	8L5881 [8]	STR-4202
CATERPILLAR	3Y8852 [8]	STR-4303	CATERPILLAR	6N3122 [17]	STR-4302	CATERPILLAR	8L8205	STR-4250
CATERPILLAR	4L9547 [17]	STR-4200	CATERPILLAR	6N3122 [8]	STR-4302	CATERPILLAR	8L8206 [17]	STR-4200
CATERPILLAR	4L9547 [8]	STR-4200	CATERPILLAR	6N5405 [17]	STR-4302	CATERPILLAR	8L8206 [8]	STR-4200
CATERPILLAR	4N0956 [17]	STR-4200	CATERPILLAR	6N5405 [8]	STR-4302	CATERPILLAR	8N2105 [17]	STR-4303

INTERCHANGE DATA

Manufacturer	OEM Part #	Meritor	Manufacturer	OEM Part #	Meritor	Manufacturer	OEM Part #	Meritor
CATERPILLAR	8N2105 [8]	STR-4303	CUMMINS	3103305	STR-4390	CUMMINS	3604234RX [12]	ALT-0050
CATERPILLAR	8N2145 [17]	STR-4303	CUMMINS	3103915	STR-4290	CUMMINS	3604321RX	STR-4302
CATERPILLAR	8N2145 [8]	STR-4303	CUMMINS	3103916	STR-4390	CUMMINS	3604322RX	STR-4200
CATERPILLAR	8S3196	STR-4251	CUMMINS	3610942	STR-4207	CUMMINS	3604323RX	STR-4202
CATERPILLAR	8S9524	STR-4251	CUMMINS	3632271	STR-4250	CUMMINS	3604481RX [4]	STR-7051
CATERPILLAR	8S9542	STR-4251	CUMMINS	3632272	STR-4250	CUMMINS	3604482RX [4]	STR-7051
CATERPILLAR	9G4338 [17]	STR-4303	CUMMINS	3632273	STR-4250	CUMMINS	3604484RX	STR-4303
CATERPILLAR	9G4338 [8]	STR-4303	CUMMINS	3632274	STR-4250	CUMMINS	3604485NW	STR-6090
CATERPILLAR	9G4339 [17]	STR-4303	CUMMINS	3902661	STR-4303	CUMMINS	3604485RX	STR-6090
CATERPILLAR	9G4339 [8]	STR-4303	CUMMINS	3904466	STR-6090	CUMMINS	3604493RX [8]	STR-4202
CATERPILLAR	9G5584 [17]	STR-4302	CUMMINS	3907622	STR-4202	CUMMINS	3604645RX	STR-4251
CATERPILLAR	9G5584 [8]	STR-4302	CUMMINS	3907821	STR-4303	CUMMINS	3604648RX	STR-7051
CATERPILLAR	9G5585 [17]	STR-4302	CUMMINS	3910645	STR-4202	CUMMINS	3604652 [12]	ALT-0050
CATERPILLAR	9G5585 [8]	STR-4302	CUMMINS	3910646	STR-4303	CUMMINS	3604656RX [17]	STR-4200
CATERPILLAR	9L3597 [8]	STR-4202	CUMMINS	3916854	STR-7051	CUMMINS	3604656RX [8]	STR-4200
CATERPILLAR	9L5938 [2]	ALT-1004	CUMMINS	3920643	STR-6090	CUMMINS	3604660NW	STR-6090
CATERPILLAR	9L6200 [17]	STR-4200	CUMMINS	3924410	STR-7056	CUMMINS	3604660RX	STR-6090
CATERPILLAR	9L6200 [8]	STR-4200	CUMMINS	3926960	STR-6090	CUMMINS	3604665RX	STR-4201
CATERPILLAR	9L6463 [2]	ALT-1004	CUMMINS	3935071	STR-7056	CUMMINS	3604666AX	ALT-1002
CATERPILLAR	9L6464	STR-4250	CUMMINS	3935527	ALT-1002	CUMMINS	3604667RX [2]	ALT-1004
CATERPILLAR	9L6474	STR-4250	CUMMINS	3935528	ALT-1004	CUMMINS	3604668RX [2]	ALT-1002
CATERPILLAR	9L6484	STR-4250	CUMMINS	3935529	ALT-1004	CUMMINS	3604670RX	ALT-0050
CATERPILLAR	9L6691 [17]	STR-4302	CUMMINS	3938501	STR-4202	CUMMINS	3604784RX	STR-4303
CATERPILLAR	9L6691 [8]	STR-4302	CUMMINS	3938502	STR-4303	CUMMINS	3675120RX	STR-4303
CATERPILLAR	9M1662 [17]	STR-4303	CUMMINS	3965281	STR-0124	CUMMINS	3675127RX	STR-4209
CATERPILLAR	9M1662 [8]	STR-4303	CUMMINS	3965282	STR-0131	CUMMINS	3675128RX	STR-4210
CATERPILLAR	9N0435 [17]	STR-4302	CUMMINS	3965283	STR-0121	CUMMINS	3675148RX	STR-6006
CATERPILLAR	9N0435 [8]	STR-4302	CUMMINS	3965284	STR-0130	CUMMINS	3675149RX	STR-6001
CATERPILLAR	9N0453 [17]	STR-4302	CUMMINS	3972732	ALT-1241	CUMMINS	3675152RX	STR-5001
CATERPILLAR	9N0453 [8]	STR-4302	CUMMINS	3972734	ALT-1241	CUMMINS	3675154NW	STR-6090
CATERPILLAR	9N0716 [17]	STR-4200	CUMMINS	4081235	STR-4250	CUMMINS	3675154RX	STR-6090
CATERPILLAR	9N0716 [8]	STR-4200	CUMMINS	4081236	STR-4250	CUMMINS	3675158RX [2]	ALT-1002
CATERPILLAR	9N0721 [17]	STR-4200	CUMMINS	4081237	STR-4250	CUMMINS	3675160RX [12]	ALT-0060
CATERPILLAR	9N0721 [8]	STR-4200	CUMMINS	4081238	STR-4250	CUMMINS	3675161RX [12]	ALT-0060
CATERPILLAR	9N716	STR-4200	CUMMINS	4081239	STR-4250	CUMMINS	3675172RX	STR-7056
CATERPILLAR	9W0058 [8]	STR-4202	CUMMINS	4094949	STR-4250	CUMMINS	3675173RX	STR-7075
CATERPILLAR	9W3043	ALT-0108	CUMMINS	4094950	STR-4250	CUMMINS	3675200RX	ALT-0050
CATERPILLAR	9X4447 [17]	STR-4303	CUMMINS	4094951	STR-4250	CUMMINS	3675218RX	ALT-3640
CATERPILLAR	9X4447 [8]	STR-4303	CUMMINS	4094952	STR-4250	CUMMINS	3675219RX	ALT-3640
CATERPILLAR	9X4453 [17]	STR-4303	CUMMINS	4094953	STR-4250	CUMMINS	3675220RX	ALT-3641
CATERPILLAR	9X4453 [8]	STR-4303	CUMMINS	4095033	STR-4250	CUMMINS	3675221RX	ALT-3640
CATERPILLAR	9X4483 [17]	STR-4303	CUMMINS	4936876	ALT-1241	CUMMINS	3675222RX	ALT-1002
CATERPILLAR	9X4483 [8]	STR-4303	CUMMINS	135162 [17]	STR-4302	CUMMINS	3675232NW	ALT-3632
CATERPILLAR	SL8206 [17]	STR-4200	CUMMINS	135162 [8]	STR-4302	CUMMINS	3675233NW	ALT-3632
CATERPILLAR	SL8206 [8]	STR-4200	CUMMINS	197127 [17]	STR-4303	CUMMINS	3675233RX	ALT-3632
CUMMINS	135160	STR-4302	CUMMINS	197127 [8]	STR-4303	CUMMINS	3675233RX	ALT-3632
CUMMINS	135161	STR-4302	CUMMINS	213298 [2]	ALT-1004	CUMMINS	3675234NW	ALT-3641
CUMMINS	135163	STR-4302	CUMMINS	213299 [2]	ALT-1004	CUMMINS	3675234RX	ALT-3641
CUMMINS	157579	STR-4202	CUMMINS	216037 [12]	ALT-0050	CUMMINS	3675236RX	ALT-3632
CUMMINS	173006	STR-4302	CUMMINS	216038 [12]	ALT-0050	CUMMINS	3675240RX	ALT-1002
CUMMINS	173007	STR-4302	CUMMINS	216039 [12]	ALT-0050	CUMMINS	3675243RX	ALT-3641
CUMMINS	173184	STR-4250	CUMMINS	216040 [12]	ALT-0050	CUMMINS	3901365 [4]	STR-7051
CUMMINS	185617	STR-4202	CUMMINS	3021036 [17]	STR-4302	CUMMINS	3901386 [4]	STR-7051
CUMMINS	195827	STR-4200	CUMMINS	3021036 [8]	STR-4302	CUMMINS	3904445 [4]	STR-7051
CUMMINS	195828	STR-4200	CUMMINS	3593752RX [8]	STR-4202	CUMMINS	3905480 [4]	STR-7051
CUMMINS	195829	STR-4200	CUMMINS	3603851RX [2]	ALT-1004	CUMMINS	3909913 [4]	STR-7051
CUMMINS	195830	STR-4200	CUMMINS	3603857RX [12]	ALT-0050	CUMMINS	3920615 [2]	ALT-1004
CUMMINS	195833	STR-4200	CUMMINS	3603858 [12]	ALT-0050	CUMMINS	3920616 [2]	ALT-1002
CUMMINS	195834	STR-4200	CUMMINS	3603858RX [12]	ALT-0050	CUMMINS	3965281RX	STR-0124
CUMMINS	554560	STR-4202	CUMMINS	3603859 [12]	ALT-0050	CUMMINS	3965282RX	STR-0131
CUMMINS	555241	STR-4302	CUMMINS	3603859RX [12]	ALT-0050	CUMMINS	3965283RX	STR-0121
CUMMINS	3000576	STR-4250	CUMMINS	3603862RX [17]	STR-4302	CUMMINS	3965284RX	STR-0130
CUMMINS	3004699	STR-4250	CUMMINS	3603862RX [8]	STR-4302	CUMMINS	706620 [17]	STR-4302
CUMMINS	3004700	STR-4250	CUMMINS	3603863RX [17]	STR-4200	CUMMINS	706620 [8]	STR-4302
CUMMINS	3010125	STR-4250	CUMMINS	3603863RX [8]	STR-4200	CUMMINS	EE8013 [12]	ALT-0050
CUMMINS	3011895	STR-4303	CUMMINS	3603864RX [8]	STR-4202	CUMMINS	EE8021 [12]	ALT-0050
CUMMINS	3021034	STR-4200	CUMMINS	3603868RX	STR-4250	CUMMINS	EE8022 [12]	ALT-0050
CUMMINS	3021035	STR-4200	CUMMINS	3603877 [12]	ALT-0050	CUMMINS	EE8023 [12]	ALT-0050
CUMMINS	3021038	STR-4250	CUMMINS	3603888RX	STR-4250	CUMMINS	EE8029 [12]	ALT-0050
CUMMINS	3063771	STR-4250	CUMMINS	3604233RX [17]	STR-4303	CUMMINS	EE8033 [12]	ALT-0050
CUMMINS	3102919	STR-4294	CUMMINS	3604233RX [8]	STR-4303	CUMMINS	EE8049 [12]	ALT-0050
CUMMINS	3103304	STR-4290	CUMMINS	3604234 [12]	ALT-0050	CUMMINS	EE8060 [12]	ALT-0050

*See page 43 for all footnotes

INTERCHANGE DATA

Manufacturer	OEM Part #	Meritor	Manufacturer	OEM Part #	Meritor	Manufacturer	OEM Part #	Meritor
CUMMINS	EE8063 [12]	ALT-0050	DELCO REMY	1990259	STR-4250	DELCO REMY	1990458	STR-4200
CUMMINS	EE8068 [12]	ALT-0050	DELCO REMY	1990262	STR-4250	DELCO REMY	1990460	STR-4302
CUMMINS	EE9008 [12]	ALT-0050	DELCO REMY	1990263	STR-4250	DELCO REMY	1990461	STR-4302
DELCO REMY	8200321	STR-4392	DELCO REMY	1990264	STR-4250	DELCO REMY	1990466	STR-4202
DELCO REMY	10465438	STR-6006	DELCO REMY	1990269	STR-4250	DELCO REMY	1990467	STR-4202
DELCO REMY	10465442	STR-5001	DELCO REMY	1990270	STR-4250	DELCO REMY	1990468	STR-4200
DELCO REMY	1109022	STR-4250	DELCO REMY	1990273	STR-4250	DELCO REMY	1990469	STR-4202
DELCO REMY	1109285	STR-4250	DELCO REMY	1990274	STR-4250	DELCO REMY	1990470	STR-4200
DELCO REMY	1109286	STR-4250	DELCO REMY	1990276	STR-4250	DELCO REMY	1990471	STR-4202
DELCO REMY	1109288	STR-4250	DELCO REMY	1990337	STR-4200	DELCO REMY	1990475	STR-4200
DELCO REMY	1109290	STR-4250	DELCO REMY	1990344	STR-4302	DELCO REMY	1990476	STR-4200
DELCO REMY	1109291	STR-4250	DELCO REMY	1990348	STR-4200	DELCO REMY	1990477	STR-4200
DELCO REMY	1109292	STR-4250	DELCO REMY	1990349	STR-4209	DELCO REMY	1990478	STR-4200
DELCO REMY	1109296	STR-4250	DELCO REMY	1990352	STR-4200	DELCO REMY	1990483	STR-4200
DELCO REMY	1109298	STR-4250	DELCO REMY	1990353	STR-4202	DELCO REMY	1990484	STR-4201
DELCO REMY	1109494	STR-4250	DELCO REMY	1990354	STR-4200	DELCO REMY	1990485	STR-4302
DELCO REMY	1109497	STR-4251	DELCO REMY	1990355	STR-4201	DELCO REMY	1990489	STR-4208
DELCO REMY	1109553	STR-4250	DELCO REMY	1990356	STR-4202	DELCO REMY	1990490	STR-4207
DELCO REMY	1109631	STR-4250	DELCO REMY	1990357	STR-4303	DELCO REMY	1990491	STR-4302
DELCO REMY	1109632	STR-4251	DELCO REMY	1990359	STR-4303	DELCO REMY	1990492	STR-4202
DELCO REMY	1109642	STR-4250	DELCO REMY	1990360	STR-4303	DELCO REMY	1990493	STR-4302
DELCO REMY	1109643	STR-4250	DELCO REMY	1990361	STR-4302	DELCO REMY	1990495	STR-4200
DELCO REMY	1109647	STR-4250	DELCO REMY	1990362	STR-4202	DELCO REMY	1990496	STR-4202
DELCO REMY	1109649	STR-4250	DELCO REMY	1990363	STR-4200	DELCO REMY	1990497	STR-4303
DELCO REMY	1109755	STR-4250	DELCO REMY	1990364	STR-4303	DELCO REMY	1993776	STR-4201
DELCO REMY	1109757	STR-4251	DELCO REMY	1990366	STR-4303	DELCO REMY	1993781	STR-4251
DELCO REMY	1109759	STR-4250	DELCO REMY	1990367	STR-4302	DELCO REMY	1993782	STR-4202
DELCO REMY	1109768	STR-4250	DELCO REMY	1990368	STR-4302	DELCO REMY	1993783	STR-4202
DELCO REMY	1109771	STR-4250	DELCO REMY	1990369	STR-4202	DELCO REMY	1993788	STR-4304
DELCO REMY	1109772	STR-4250	DELCO REMY	1990370	STR-4202	DELCO REMY	1993795	STR-4202
DELCO REMY	1109774	STR-4250	DELCO REMY	1990372	STR-4209	DELCO REMY	1993796	STR-4303
DELCO REMY	1109775	STR-4250	DELCO REMY	1990373	STR-4303	DELCO REMY	1993797	STR-4303
DELCO REMY	1109776	STR-4250	DELCO REMY	1990374	STR-4202	DELCO REMY	1993802	STR-4302
DELCO REMY	1109777	STR-4250	DELCO REMY	1990375	STR-4200	DELCO REMY	1993803	STR-4200
DELCO REMY	1109779	STR-4251	DELCO REMY	1990376	STR-4200	DELCO REMY	1993804	STR-4303
DELCO REMY	1109780	STR-4250	DELCO REMY	1990378	STR-4302	DELCO REMY	1993805	STR-4302
DELCO REMY	1109791	STR-4250	DELCO REMY	1990379	STR-4202	DELCO REMY	1993806	STR-4202
DELCO REMY	1109792	STR-4251	DELCO REMY	1990382	STR-4302	DELCO REMY	1993807	STR-4200
DELCO REMY	1109839	STR-4250	DELCO REMY	1990383	STR-4302	DELCO REMY	1993808	STR-4303
DELCO REMY	1109840	STR-4250	DELCO REMY	1990386	STR-4200	DELCO REMY	1993810	STR-4302
DELCO REMY	1109841	STR-4250	DELCO REMY	1990388	STR-4302	DELCO REMY	1993811	STR-4202
DELCO REMY	1109842	STR-4250	DELCO REMY	1990391	STR-4201	DELCO REMY	1993813	STR-4209
DELCO REMY	1109845	STR-4250	DELCO REMY	1990394	STR-4202	DELCO REMY	1993814	STR-4303
DELCO REMY	1109846	STR-4250	DELCO REMY	1990396	STR-4200	DELCO REMY	1993815	STR-4303
DELCO REMY	1109849	STR-4251	DELCO REMY	1990397	STR-4210	DELCO REMY	1993816	STR-4200
DELCO REMY	1109949	STR-4251	DELCO REMY	1990398	STR-4200	DELCO REMY	1993820	STR-4202
DELCO REMY	1109961	STR-4250	DELCO REMY	1990400	STR-4200	DELCO REMY	1993824	STR-4206
DELCO REMY	1109965	STR-4250	DELCO REMY	1990401	STR-4202	DELCO REMY	1993825	STR-4250
DELCO REMY	1109979	STR-4250	DELCO REMY	1990402	STR-4303	DELCO REMY	1993833	STR-4303
DELCO REMY	1109986	STR-4250	DELCO REMY	1990403	STR-4202	DELCO REMY	1993840	STR-4250
DELCO REMY	1113267	STR-7055	DELCO REMY	1990404	STR-4202	DELCO REMY	1993841	STR-4250
DELCO REMY	1113270	STR-7055	DELCO REMY	1990405	STR-4202	DELCO REMY	1993842	STR-4302
DELCO REMY	1113271	STR-7072	DELCO REMY	1990406	STR-4206	DELCO REMY	1993856	STR-4209
DELCO REMY	1113275	STR-7054	DELCO REMY	1990407	STR-4202	DELCO REMY	1993860	STR-4250
DELCO REMY	1113276	STR-7051	DELCO REMY	1990408	STR-4206	DELCO REMY	1993933	STR-4302
DELCO REMY	1113278	STR-7054	DELCO REMY	1990413	STR-4303	DELCO REMY	1993934	STR-4200
DELCO REMY	1113296	STR-7055	DELCO REMY	1990416	STR-4302	DELCO REMY	1993935	STR-4202
DELCO REMY	1114723	STR-4200	DELCO REMY	1990418	STR-4302	DELCO REMY	1993936	STR-4303
DELCO REMY	1114733	STR-4202	DELCO REMY	1990419	STR-4202	DELCO REMY	1993937	STR-4202
DELCO REMY	1114951	STR-4302	DELCO REMY	1990420	STR-4200	DELCO REMY	1993938	STR-4202
DELCO REMY	1114961	STR-4200	DELCO REMY	1990421	STR-4201	DELCO REMY	1993939	STR-4202
DELCO REMY	1114977	STR-4202	DELCO REMY	1990422	STR-4302	DELCO REMY	1993941	STR-4302
DELCO REMY	1990229	STR-4250	DELCO REMY	1990423	STR-4200	DELCO REMY	1993943	STR-4202
DELCO REMY	1990231	STR-4250	DELCO REMY	1990424	STR-4200	DELCO REMY	1993944	STR-4303
DELCO REMY	1990232	STR-4251	DELCO REMY	1990427	STR-4206	DELCO REMY	1993973	STR-4210
DELCO REMY	1990235	STR-4250	DELCO REMY	1990428	STR-4201	DELCO REMY	1993975	STR-4200
DELCO REMY	1990237	STR-4250	DELCO REMY	1990429	STR-4202	DELCO REMY	1993982	STR-4200
DELCO REMY	1990240	STR-4251	DELCO REMY	1990437	STR-4302	DELCO REMY	1993983	STR-4202
DELCO REMY	1990248	STR-4250	DELCO REMY	1990450	STR-4200	DELCO REMY	1993984	STR-4206
DELCO REMY	1990249	STR-4250	DELCO REMY	1990453	STR-4303	DELCO REMY	1993993	STR-4303
DELCO REMY	1990250	STR-4250	DELCO REMY	1990455	STR-4303	DELCO REMY	8200000	STR-0130
DELCO REMY	1990251	STR-4250	DELCO REMY	1990456	STR-4302	DELCO REMY	8200005	STR-0121

INTERCHANGE DATA

Manufacturer	OEM Part #	Meritor	Manufacturer	OEM Part #	Meritor	Manufacturer	OEM Part #	Meritor
DELCO REMY	8200007	STR-0122	DELCO REMY	8300014	STR-4391	DELCO REMY	8700016	ALT-3652
DELCO REMY	8200009	STR-4390	DELCO REMY	8300014	STR-4393	DELCO REMY	8700017	ALT-3651
DELCO REMY	8200009	STR-4390B	DELCO REMY	8300015	STR-4294	DELCO REMY	8700018	ALT-3650
DELCO REMY	8200010	STR-0140	DELCO REMY	8300016	STR-4390	DELCO REMY	8700021	ALT-1241
DELCO REMY	8200011	STR-0141	DELCO REMY	8300017	STR-4292	DELCO REMY	8700023	ALT-3652
DELCO REMY	8200022	STR-4390	DELCO REMY	8300018	STR-4390	DELCO REMY	8700025	ALT-3651
DELCO REMY	8200023	STR-0124	DELCO REMY	8300019	STR-4290	DELCO REMY	8700026	ALT-3652
DELCO REMY	8200024	STR-0131	DELCO REMY	8300020	STR-4292	DELCO REMY	8700027	ALT-3651
DELCO REMY	8200025	STR-0121	DELCO REMY	8300021	STR-0120	DELCO REMY	8700028	ALT-3652
DELCO REMY	8200027	STR-4391	DELCO REMY	8300022	STR-0122	DELCO REMY	8700029	ALT-3651
DELCO REMY	8200027	STR-4393	DELCO REMY	8300023	STR-0131	DELCO REMY	8700030	ALT-3650
DELCO REMY	8200028	STR-4294	DELCO REMY	8300024	STR-0124	DELCO REMY	8700039	ALT-3600
DELCO REMY	8200029	STR-4391	DELCO REMY	8300025	STR-0130	DELCO REMY	8700040	ALT-3600
DELCO REMY	8200029	STR-4393	DELCO REMY	8300026	STR-0123	DELCO REMY	8700041	ALT-3602
DELCO REMY	8200030	STR-4294	DELCO REMY	8300061	STR-4295	DELCO REMY	8700045	ALT-3601
DELCO REMY	8200031	STR-4292	DELCO REMY	8400003	ALT-1511	DELCO REMY	8700046	ALT-3602
DELCO REMY	8200032	STR-4390	DELCO REMY	8600009	ALT-1241	DELCO REMY	8700047	ALT-3600
DELCO REMY	8200033	STR-4290	DELCO REMY	8600015	ALT-3600	DELCO REMY	10459141	ALT-3632
DELCO REMY	8200034	STR-4390	DELCO REMY	8600018	ALT-1241	DELCO REMY	10459142	ALT-3632
DELCO REMY	8200037	STR-4292	DELCO REMY	8600019	ALT-1241	DELCO REMY	10459143	ALT-3632
DELCO REMY	8200038	STR-4292	DELCO REMY	8600032	ALT-1241	DELCO REMY	10459144	ALT-3632
DELCO REMY	8200039	STR-4390	DELCO REMY	8600043	ALT-1240	DELCO REMY	10459145	ALT-3641
DELCO REMY	8200040	STR-4290	DELCO REMY	8600055	ALT-3600	DELCO REMY	10459180	ALT-3632
DELCO REMY	8200041	STR-4390	DELCO REMY	8600060	ALT-3600	DELCO REMY	10459181	ALT-3632
DELCO REMY	8200042	STR-4294	DELCO REMY	8600064	ALT-3652	DELCO REMY	10459182	ALT-3632
DELCO REMY	8200043	STR-4391	DELCO REMY	8600065	ALT-3651	DELCO REMY	10459183	ALT-3632
DELCO REMY	8200043	STR-4393	DELCO REMY	8600066	ALT-3650	DELCO REMY	10459184	ALT-3641
DELCO REMY	8200044	STR-4391	DELCO REMY	8600068	ALT-1241	DELCO REMY	10459188	ALT-1002
DELCO REMY	8200044	STR-4393	DELCO REMY	8600071	ALT-3601	DELCO REMY	10459189	ALT-1002
DELCO REMY	8200045	STR-4294	DELCO REMY	8600072	ALT-3602	DELCO REMY	10459190	ALT-1002
DELCO REMY	8200050	STR-4292	DELCO REMY	8600073	ALT-3600	DELCO REMY	10459192	ALT-1002
DELCO REMY	8200058	STR-4294	DELCO REMY	8600082	ALT-3602	DELCO REMY	10459193	ALT-1002
DELCO REMY	8200067	STR-0143	DELCO REMY	8600100	ALT-1240	DELCO REMY	10459194	ALT-3632
DELCO REMY	8200072	STR-0130	DELCO REMY	8600125	ALT-3601	DELCO REMY	10459195	ALT-3632
DELCO REMY	8200075	STR-0123	DELCO REMY	8600126	ALT-3602	DELCO REMY	10459197	ALT-3641
DELCO REMY	8200076	STR-0120	DELCO REMY	8600127	ALT-3600	DELCO REMY	10459198	ALT-3641
DELCO REMY	8200077	STR-0124	DELCO REMY	8600142	ALT-1241	DELCO REMY	10459204	ALT-1002
DELCO REMY	8200078	STR-0131	DELCO REMY	8600143	ALT-1240	DELCO REMY	10459205	ALT-1004
DELCO REMY	8200081	STR-4295	DELCO REMY	8600151	ALT-1241	DELCO REMY	10459206	ALT-3641
DELCO REMY	8200082	STR-4293	DELCO REMY	8600152	ALT-1241	DELCO REMY	10459212	ALT-1004
DELCO REMY	8200084	STR-4291	DELCO REMY	8600163	ALT-1241	DELCO REMY	10459216	ALT-1004
DELCO REMY	8200085	STR-4294	DELCO REMY	8600164	ALT-1241	DELCO REMY	10459255	ALT-1002
DELCO REMY	8200086	STR-4391	DELCO REMY	8600165	ALT-1241	DELCO REMY	10459278	ALT-3640
DELCO REMY	8200087	STR-4294	DELCO REMY	8600167	ALT-1240	DELCO REMY	10459279	ALT-3640
DELCO REMY	8200088	STR-4292	DELCO REMY	8600168	ALT-1240	DELCO REMY	10459284	ALT-3640
DELCO REMY	8200090	STR-4292	DELCO REMY	8600171	ALT-3600	DELCO REMY	10459285	ALT-3640
DELCO REMY	8200091	STR-4292	DELCO REMY	8600177	ALT-3602	DELCO REMY	10459287	ALT-3641
DELCO REMY	8200104	STR-4292	DELCO REMY	8600178	ALT-3600	DELCO REMY	10459288	ALT-3640
DELCO REMY	8200182	STR-4294	DELCO REMY	8600194	ALT-3650	DELCO REMY	10459289	ALT-3640
DELCO REMY	8200186	STR-4294	DELCO REMY	8600203	ALT-3600	DELCO REMY	10459290	ALT-3641
DELCO REMY	8200218	STR-4295	DELCO REMY	8600223	ALT-1281	DELCO REMY	10459318	ALT-1003
DELCO REMY	8200219	STR-4295	DELCO REMY	8600307	ALT-1282	DELCO REMY	10459320	ALT-1003
DELCO REMY	8200287	STR-4293	DELCO REMY	8600310	ALT-1241	DELCO REMY	10459321	ALT-1003
DELCO REMY	8200288	STR-4292	DELCO REMY	8600311	ALT-1282	DELCO REMY	10459360	ALT-1002
DELCO REMY	8200289	STR-4292	DELCO REMY	8600313	ALT-1281	DELCO REMY	10459449	ALT-3640
DELCO REMY	8200290	STR-4292	DELCO REMY	8600314	ALT-1280	DELCO REMY	10459450	ALT-3632
DELCO REMY	8200291	STR-4295	DELCO REMY	8600316	ALT-1280	DELCO REMY	10459451	ALT-3641
DELCO REMY	8200308	STR-4292	DELCO REMY	8600889	ALT-1240	DELCO REMY	10459472	ALT-1004
DELCO REMY	8200321	STR-4392B	DELCO REMY	8700000	ALT-3652	DELCO REMY	10459551	ALT-0050
DELCO REMY	8200327	STR-4392B	DELCO REMY	8700001	ALT-3650	DELCO REMY	10459555	ALT-0050
DELCO REMY	8200360	STR-4295	DELCO REMY	8700002	ALT-3650	DELCO REMY	10459606	ALT-3652
DELCO REMY	8200433	STR-4295	DELCO REMY	8700003	ALT-3651	DELCO REMY	10459607	ALT-3651
DELCO REMY	8200434	STR-4292	DELCO REMY	8700004	ALT-3650	DELCO REMY	10459608	ALT-3650
DELCO REMY	8200469	STR-4295	DELCO REMY	8700005	ALT-3652	DELCO REMY	10459609	ALT-3652
DELCO REMY	8300004	STR-4294	DELCO REMY	8700006	ALT-3651	DELCO REMY	10459610	ALT-3651
DELCO REMY	8300005	STR-0121	DELCO REMY	8700007	ALT-3650	DELCO REMY	10459611	ALT-3650
DELCO REMY	8300007	STR-4295	DELCO REMY	8700008	ALT-1240	DELCO REMY	10459612	ALT-3652
DELCO REMY	8300008	STR-4293	DELCO REMY	8700009	ALT-1241	DELCO REMY	10459613	ALT-3651
DELCO REMY	8300009	STR-4292	DELCO REMY	8700010	ALT-1241	DELCO REMY	10459614	ALT-3650
DELCO REMY	8300011	STR-4391	DELCO REMY	8700011	ALT-1241	DELCO REMY	10459615	ALT-3652
DELCO REMY	8300012	STR-4294	DELCO REMY	8700012	ALT-1240	DELCO REMY	10459617	ALT-3650
DELCO REMY	8300013	STR-4291	DELCO REMY	8700013	ALT-1240	DELCO REMY	10461021	STR-4202

*See page 43 for all footnotes

INTERCHANGE DATA

Manufacturer	OEM Part #	Meritor	Manufacturer	OEM Part #	Meritor	Manufacturer	OEM Part #	Meritor
DELCO REMY	10461025	STR-4303	DELCO REMY	10461756	STR-4390	DELCO REMY	10479021	STR-4200
DELCO REMY	10461028	STR-4201	DELCO REMY	10461757	STR-4294	DELCO REMY	10479037	STR-4200
DELCO REMY	10461030	STR-4302	DELCO REMY	10461758	STR-4391	DELCO REMY	10479038	STR-4201
DELCO REMY	10461031	STR-4303	DELCO REMY	10461759	STR-4391	DELCO REMY	10479052	STR-4202
DELCO REMY	10461032	STR-4202	DELCO REMY	10461760	STR-4294	DELCO REMY	10479053	STR-4303
DELCO REMY	10461033	STR-4200	DELCO REMY	10461764	STR-0144	DELCO REMY	10479062	STR-4201
DELCO REMY	10461036	STR-4209	DELCO REMY	10461765	STR-0142	DELCO REMY	10479063	STR-4209
DELCO REMY	10461038	STR-4200	DELCO REMY	10461768	STR-0121	DELCO REMY	10479064	STR-4210
DELCO REMY	10461042	STR-4207	DELCO REMY	10461770	STR-0140	DELCO REMY	10479065	STR-4200
DELCO REMY	10461043	STR-4302	DELCO REMY	10461771	STR-0143	DELCO REMY	10479067	STR-4304
DELCO REMY	10461045	STR-4200	DELCO REMY	10461772	STR-0141	DELCO REMY	10479072	STR-4200
DELCO REMY	10461050	STR-4202	DELCO REMY	10461773	STR-4293	DELCO REMY	10479081	STR-4200
DELCO REMY	10461051	STR-4202	DELCO REMY	10461774	STR-0130	DELCO REMY	10479082	STR-4201
DELCO REMY	10461052	STR-4200	DELCO REMY	10461776	STR-0131	DELCO REMY	10479100	STR-4303
DELCO REMY	10461053	STR-4207	DELCO REMY	10461777	STR-4290	DELCO REMY	10479104	STR-4207
DELCO REMY	10461054	STR-4302	DELCO REMY	10464453	ALT-1511	DELCO REMY	10479105	STR-4208
DELCO REMY	10461055	STR-4201	DELCO REMY	10464476	ALT-1511	DELCO REMY	10479110	STR-4200
DELCO REMY	10461057	STR-4250	DELCO REMY	10465014	STR-7055	DELCO REMY	10479111	STR-4302
DELCO REMY	10461062	STR-4208	DELCO REMY	10465026	STR-7051	DELCO REMY	10479112	STR-4200
DELCO REMY	10461063	STR-4206	DELCO REMY	10465043	STR-7051	DELCO REMY	10479113	STR-4200
DELCO REMY	10461068	STR-4302	DELCO REMY	10465045	STR-7054	DELCO REMY	10479114	STR-4302
DELCO REMY	10461075	STR-4208	DELCO REMY	10465046	STR-7054	DELCO REMY	10479115	STR-4303
DELCO REMY	10461076	STR-4209	DELCO REMY	10465054	STR-7055	DELCO REMY	10479117	STR-4202
DELCO REMY	10461077	STR-4209	DELCO REMY	10465150	STR-7075	DELCO REMY	10479118	STR-4303
DELCO REMY	10461078	STR-4210	DELCO REMY	10465151	STR-7056	DELCO REMY	10479119	STR-4302
DELCO REMY	10461079	STR-4206	DELCO REMY	10465168	STR-7055	DELCO REMY	10479120	STR-4303
DELCO REMY	10461080	STR-4304	DELCO REMY	10465314	STR-7056	DELCO REMY	10479124	STR-4250
DELCO REMY	10461090	STR-4209	DELCO REMY	10465397	STR-7075	DELCO REMY	10479125	STR-4250
DELCO REMY	10461091	STR-4209	DELCO REMY	10465402	STR-7075	DELCO REMY	10479126	STR-4250
DELCO REMY	10461096	STR-4201	DELCO REMY	10465403	STR-7051	DELCO REMY	10479130	STR-4304
DELCO REMY	10461125	STR-4250	DELCO REMY	10465406	STR-7054	DELCO REMY	10479131	STR-4206
DELCO REMY	10461126	STR-4200	DELCO REMY	10465407	STR-7051	DELCO REMY	10479136	STR-4303
DELCO REMY	10461127	STR-4207	DELCO REMY	10465540	STR-6090	DELCO REMY	10479142	STR-4304
DELCO REMY	10461128	STR-4302	DELCO REMY	10478804	STR-4202	DELCO REMY	10479147	STR-4206
DELCO REMY	10461136	STR-4303	DELCO REMY	10478809	STR-4200	DELCO REMY	10479149	STR-4302
DELCO REMY	10461141	STR-4304	DELCO REMY	10478832	STR-4200	DELCO REMY	10479150	STR-4200
DELCO REMY	10461143	STR-4302	DELCO REMY	10478833	STR-4200	DELCO REMY	10479151	STR-4201
DELCO REMY	10461178	STR-4200	DELCO REMY	10478835	STR-4202	DELCO REMY	10479164	STR-4302
DELCO REMY	10461183	STR-4201	DELCO REMY	10478894	STR-4200	DELCO REMY	10479168	STR-4302
DELCO REMY	10461184	STR-4302	DELCO REMY	10478895	STR-4200	DELCO REMY	10479178	STR-4303
DELCO REMY	10461185	STR-4208	DELCO REMY	10478918	STR-4202	DELCO REMY	10479191	STR-4202
DELCO REMY	10461206	STR-4206	DELCO REMY	10478931	STR-4202	DELCO REMY	10479192	STR-4206
DELCO REMY	10461226	ALT-3641	DELCO REMY	10478934	STR-4202	DELCO REMY	10479228	STR-4305
DELCO REMY	10461228	STR-4210	DELCO REMY	10478935	STR-4200	DELCO REMY	10479264	STR-4303
DELCO REMY	10461232	STR-4201	DELCO REMY	10478936	STR-4202	DELCO REMY	10479288	STR-4305
DELCO REMY	10461233	STR-4206	DELCO REMY	10478937	STR-4302	DELCO REMY	10479290	STR-4302
DELCO REMY	10461234	ALT-3641	DELCO REMY	10478938	STR-4302	DELCO REMY	10479614	STR-7075
DELCO REMY	10461242	STR-4303	DELCO REMY	10478939	STR-4303	DELCO REMY	10479615	STR-7056
DELCO REMY	10461259	STR-4302	DELCO REMY	10478941	STR-4303	DELCO REMY	10479618	STR-7056
DELCO REMY	10461326	STR-4200	DELCO REMY	10478942	STR-4303	DELCO REMY	10479621	STR-7051
DELCO REMY	10461328	STR-4202	DELCO REMY	10478943	STR-4302	DELCO REMY	10479625	STR-7056
DELCO REMY	10461334	STR-4290	DELCO REMY	10478944	STR-4303	DELCO REMY	10479632	STR-7075
DELCO REMY	10461345	STR-4303	DELCO REMY	10478946	STR-4302	DELCO REMY	10479638	STR-7056
DELCO REMY	10461358	STR-4303	DELCO REMY	10478947	STR-4303	DELCO REMY	10479640	STR-7051
DELCO REMY	10461359	STR-4302	DELCO REMY	10478952	STR-4302	DELCO REMY	10479641	STR-7056
DELCO REMY	10461360	STR-4302	DELCO REMY	10478963	STR-4200	DELCO REMY	10479643	STR-7051
DELCO REMY	10461362	STR-4304	DELCO REMY	10478964	STR-4201	DELCO REMY	10479644	STR-7056
DELCO REMY	10461392	STR-4200	DELCO REMY	10478980	STR-4302	DELCO REMY	10480234	ALT-1511
DELCO REMY	10461398	STR-4202	DELCO REMY	10478983	STR-4200	DELCO REMY	10480390	ALT-1511
DELCO REMY	10461411	STR-4207	DELCO REMY	10478986	STR-4302	DELCO REMY	15200109	ALT-1511
DELCO REMY	10461414	STR-4202	DELCO REMY	10478987	STR-4200	DELCO REMY	15226003	ALT-1511
DELCO REMY	10461443	STR-7072	DELCO REMY	10478988	STR-4302	DELCO REMY	15750871	ALT-1511
DELCO REMY	10461446	STR-7054	DELCO REMY	10478990	STR-4302	DELCO REMY	15754097	ALT-1511
DELCO REMY	10461447	STR-7054	DELCO REMY	10478994	STR-4202	DELCO REMY	19010507	STR-4390
DELCO REMY	10461477	STR-7056	DELCO REMY	10478995	STR-4303	DELCO REMY	19010509	STR-4390
DELCO REMY	10461479	STR-7051	DELCO REMY	10478998	STR-4302	DELCO REMY	19011150	ALT-3632
DELCO REMY	10461480	STR-7056	DELCO REMY	10479003	STR-4202	DELCO REMY	19011151	ALT-3632
DELCO REMY	10461498	STR-7006	DELCO REMY	10479004	STR-4202	DELCO REMY	19011152	ALT-3632
DELCO REMY	10461630	STR-6052	DELCO REMY	10479006	STR-4200	DELCO REMY	19011154	ALT-3632
DELCO REMY	10461753	STR-4290	DELCO REMY	10479009	STR-4303	DELCO REMY	19011155	ALT-3632
DELCO REMY	10461754	STR-4390	DELCO REMY	10479010	STR-4302	DELCO REMY	19011156	ALT-3632
DELCO REMY	10461755	STR-4292	DELCO REMY	10479017	STR-4207	DELCO REMY	19011157	ALT-3641

INTERCHANGE DATA

Manufacturer	OEM Part #	Meritor	Manufacturer	OEM Part #	Meritor	Manufacturer	OEM Part #	Meritor
DELCO REMY	19011158	ALT-3632	DELCO REMY	19011516	STR-4292	DELCO REMY	10459038 [2]	ALT-1004
DELCO REMY	19011159	ALT-3632	DELCO REMY	19011517	STR-4294	DELCO REMY	10459039 [2]	ALT-1002
DELCO REMY	19011160	ALT-3632	DELCO REMY	19011518	STR-4290	DELCO REMY	10459040 [2]	ALT-1004
DELCO REMY	19011161	ALT-3632	DELCO REMY	19011519	STR-4290	DELCO REMY	10459041 [2]	ALT-1004
DELCO REMY	19011162	ALT-3632	DELCO REMY	19011521	STR-4290	DELCO REMY	10459045 [2]	ALT-1002
DELCO REMY	19011163	ALT-3632	DELCO REMY	19011522	STR-4390	DELCO REMY	10459047 [2]	ALT-1004
DELCO REMY	19011167	ALT-3641	DELCO REMY	19011523	STR-4390	DELCO REMY	10459048 [2]	ALT-1004
DELCO REMY	19011169	ALT-3641	DELCO REMY	19011524	STR-4391	DELCO REMY	10459050 [2]	ALT-1002
DELCO REMY	19011170	ALT-3641	DELCO REMY	19011525	STR-4291	DELCO REMY	10459051 [2]	ALT-1002
DELCO REMY	19011171	ALT-3632	DELCO REMY	19011526	STR-4295	DELCO REMY	10459052 [2]	ALT-1002
DELCO REMY	19011172	ALT-3641	DELCO REMY	19011529	STR-4290	DELCO REMY	10459053 [2]	ALT-1002
DELCO REMY	19011173	ALT-3632	DELCO REMY	19011530	STR-4290	DELCO REMY	10459054 [2]	ALT-1002
DELCO REMY	19011174	ALT-3632	DELCO REMY	19011531	STR-4290	DELCO REMY	10459081 [12]	ALT-0060
DELCO REMY	19011176	ALT-3640	DELCO REMY	19020300	ALT-1002	DELCO REMY	10459084 [12]	ALT-0060
DELCO REMY	19011177	ALT-3640	DELCO REMY	19020302	ALT-1002	DELCO REMY	10459105 [2]	ALT-1004
DELCO REMY	19011179	ALT-3641	DELCO REMY	19020303	ALT-1002	DELCO REMY	10459117 [2]	ALT-1004
DELCO REMY	19011187	ALT-3640	DELCO REMY	19020304	ALT-1004	DELCO REMY	10459139 [12]	ALT-0050
DELCO REMY	19011200	ALT-3632	DELCO REMY	19020305	ALT-1002	DELCO REMY	10459140 [12]	ALT-0050
DELCO REMY	19011201	ALT-3641	DELCO REMY	19020306	ALT-1004	DELCO REMY	10459160 [2]	ALT-1002
DELCO REMY	19011202	ALT-3640	DELCO REMY	19020308	ALT-1002	DELCO REMY	10459208 [12]	ALT-0060
DELCO REMY	19011211	ALT-3632	DELCO REMY	19020309	ALT-1004	DELCO REMY	10459277 [2]	ALT-1002
DELCO REMY	19011212	ALT-3632	DELCO REMY	19020310	ALT-1004	DELCO REMY	10459458 [12]	ALT-0050
DELCO REMY	19011213	ALT-3641	DELCO REMY	19020312	ALT-1002	DELCO REMY	10459459 [12]	ALT-0060
DELCO REMY	19011214	ALT-3641	DELCO REMY	19020314	ALT-1002	DELCO REMY	10461045 [8]	STR-4200
DELCO REMY	19011215	ALT-3640	DELCO REMY	19020354	ALT-1002	DELCO REMY	10461046 [8]	STR-4202
DELCO REMY	19011216	ALT-3640	DELCO REMY	19020355	ALT-1004	DELCO REMY	10461047 [17]	STR-4302
DELCO REMY	19011225	ALT-3652	DELCO REMY	19020356	ALT-1004	DELCO REMY	10461047 [8]	STR-4302
DELCO REMY	19011226	ALT-3650	DELCO REMY	19020357	ALT-1004	DELCO REMY	10461107 [17]	STR-4303
DELCO REMY	19011227	ALT-3652	DELCO REMY	19020358	ALT-1002	DELCO REMY	10461107 [8]	STR-4303
DELCO REMY	19011228	ALT-3652	DELCO REMY	19020359	ALT-1002	DELCO REMY	10461178 [8]	STR-4200
DELCO REMY	19011229	ALT-3652	DELCO REMY	19020360	ALT-1002	DELCO REMY	10461179 [17]	STR-4302
DELCO REMY	19011231	ALT-3652	DELCO REMY	19020362	ALT-1002	DELCO REMY	10461179 [8]	STR-4302
DELCO REMY	19011232	ALT-3652	DELCO REMY	19020363	ALT-1002	DELCO REMY	10461639 [4]	STR-7072
DELCO REMY	19011234	ALT-3651	DELCO REMY	19020365	ALT-1002	DELCO REMY	10461670 [4]	STR-7072
DELCO REMY	19011244	ALT-3651	DELCO REMY	19020377	ALT-1002	DELCO REMY	10461678 [4]	STR-7072
DELCO REMY	19011246	ALT-3651	DELCO REMY	19020379	ALT-1002	DELCO REMY	10463072 [2]	ALT-1004
DELCO REMY	19011248	ALT-3652	DELCO REMY	19020380	ALT-1004	DELCO REMY	10463073 [2]	ALT-1004
DELCO REMY	19011249	ALT-3651	DELCO REMY	19020381	ALT-1004	DELCO REMY	10465149 [4]	STR-7051
DELCO REMY	19011252	ALT-3650	DELCO REMY	19020387	ALT-1003	DELCO REMY	10465347 [4]	STR-7072
DELCO REMY	19011253	ALT-3650	DELCO REMY	19020388	ALT-1003	DELCO REMY	10465399 [11]	STR-7005
DELCO REMY	19011255	ALT-3651	DELCO REMY	19020389	ALT-1003	DELCO REMY	10486883 [4]	STR-7051
DELCO REMY	19011258	ALT-3650	DELCO REMY	19020801	ALT-1002	DELCO REMY	10496881 [4]	STR-7054
DELCO REMY	19011260	ALT-3652	DELCO REMY	19020802	ALT-1002	DELCO REMY	10496882 [4]	STR-7051
DELCO REMY	19011261	ALT-3651	DELCO REMY	19020803	ALT-1003	DELCO REMY	10496883 [4]	STR-7051
DELCO REMY	19011262	ALT-3650	DELCO REMY	19020804	ALT-1003	DELCO REMY	10496885 [4]	STR-7072
DELCO REMY	19011263	ALT-3652	DELCO REMY	19020806	ALT-1002	DELCO REMY	10497165 [4]	STR-7055
DELCO REMY	19011264	ALT-3652	DELCO REMY	19020888	ALT-1003	DELCO REMY	1100072 [2]	ALT-1004
DELCO REMY	19011265	ALT-3651	DELCO REMY	19020889	ALT-1003	DELCO REMY	1100073 [2]	ALT-1004
DELCO REMY	19011266	ALT-3651	DELCO REMY	19020900	ALT-1240	DELCO REMY	1100080 [2]	ALT-1004
DELCO REMY	19011267	ALT-3650	DELCO REMY	19020901	ALT-1241	DELCO REMY	1100081 [2]	ALT-1004
DELCO REMY	19011268	ALT-3650	DELCO REMY	19020902	ALT-1240	DELCO REMY	1100084 [2]	ALT-1004
DELCO REMY	19011272	ALT-3650	DELCO REMY	19020903	ALT-1241	DELCO REMY	1100086 [2]	ALT-1004
DELCO REMY	19011273	ALT-3650	DELCO REMY	19025330	ALT-T145	DELCO REMY	1100087 [2]	ALT-1004
DELCO REMY	19011400	STR-0140	DELCO REMY	19025331	ALT-T141	DELCO REMY	1100089 [2]	ALT-1004
DELCO REMY	19011402	STR-0143	DELCO REMY	19025333	ALT-T150	DELCO REMY	1100090 [2]	ALT-1004
DELCO REMY	19011403	STR-0141	DELCO REMY	19025336	ALT-T141	DELCO REMY	1100185 [2]	ALT-1004
DELCO REMY	19011404	STR-0144	DELCO REMY	19025337	ALT-T141	DELCO REMY	1100188 [2]	ALT-1004
DELCO REMY	19011407	STR-0144	DELCO REMY	19026026	STR-0130	DELCO REMY	1100189 [2]	ALT-1004
DELCO REMY	19011409	STR-0142	DELCO REMY	19026027	STR-0120	DELCO REMY	1100212 [2]	ALT-1004
DELCO REMY	19011500	STR-4290	DELCO REMY	19026028	STR-0121	DELCO REMY	1100213 [2]	ALT-1004
DELCO REMY	19011501	STR-4394	DELCO REMY	19026029	STR-0121	DELCO REMY	1101104 [2]	ALT-1004
DELCO REMY	19011505	STR-4290	DELCO REMY	19026030	STR-0130	DELCO REMY	1101105 [2]	ALT-1004
DELCO REMY	19011506	STR-4290	DELCO REMY	19026031	STR-0124	DELCO REMY	1101288 [2]	ALT-1004
DELCO REMY	19011507	STR-4390	DELCO REMY	19026032	STR-0131	DELCO REMY	1101289 [2]	ALT-1004
DELCO REMY	19011508	STR-4292	DELCO REMY	19026035	STR-0123	DELCO REMY	1105460 [2]	ALT-1004
DELCO REMY	19011509	STR-4390	DELCO REMY	10451047 [17]	STR-4302	DELCO REMY	1105463 [2]	ALT-1004
DELCO REMY	19011510	STR-4294	DELCO REMY	10451047 [8]	STR-4302	DELCO REMY	1105464 [2]	ALT-1004
DELCO REMY	19011511	STR-4391	DELCO REMY	10459021 [12]	ALT-0050	DELCO REMY	1105465 [2]	ALT-1004
DELCO REMY	19011512	STR-4391	DELCO REMY	10459022 [12]	ALT-0050	DELCO REMY	1105467 [2]	ALT-1004
DELCO REMY	19011513	STR-4294	DELCO REMY	10459024 [12]	ALT-0050	DELCO REMY	1105469 [2]	ALT-1004
DELCO REMY	19011514	STR-4293	DELCO REMY	10459025 [12]	ALT-0050	DELCO REMY	1105470 [2]	ALT-1004
DELCO REMY	19011515	STR-4294	DELCO REMY	10459037 [2]	ALT-1004	DELCO REMY	1107577 [4]	STR-7072

*See page 43 for all footnotes

INTERCHANGE DATA

Manufacturer	OEM Part #	Meritor	Manufacturer	OEM Part #	Meritor	Manufacturer	OEM Part #	Meritor
DELCO REMY	1114164 [8]	STR-4200	DELCO REMY	1114819 [17]	STR-4200	DELCO REMY	1114897 [8]	STR-4200
DELCO REMY	1114165 [17]	STR-4200	DELCO REMY	1114819 [8]	STR-4200	DELCO REMY	1114898 [17]	STR-4200
DELCO REMY	1114165 [8]	STR-4200	DELCO REMY	1114820 [17]	STR-4200	DELCO REMY	1114898 [8]	STR-4200
DELCO REMY	1114167 [8]	STR-4202	DELCO REMY	1114820 [8]	STR-4200	DELCO REMY	1114899 [17]	STR-4200
DELCO REMY	1114169 [8]	STR-4202	DELCO REMY	1114824 [8]	STR-4202	DELCO REMY	1114899 [8]	STR-4200
DELCO REMY	1114170 [17]	STR-4200	DELCO REMY	1114825 [8]	STR-4202	DELCO REMY	1114903 [17]	STR-4302
DELCO REMY	1114170 [8]	STR-4200	DELCO REMY	1114826 [8]	STR-4202	DELCO REMY	1114903 [8]	STR-4302
DELCO REMY	1114171 [8]	STR-4202	DELCO REMY	1114827 [8]	STR-4202	DELCO REMY	1114905 [17]	STR-4303
DELCO REMY	1114172 [17]	STR-4200	DELCO REMY	1114828 [8]	STR-4202	DELCO REMY	1114905 [8]	STR-4303
DELCO REMY	1114172 [8]	STR-4200	DELCO REMY	1114832 [8]	STR-4202	DELCO REMY	1114906 [17]	STR-4200
DELCO REMY	1114174 [8]	STR-4202	DELCO REMY	1114833 [8]	STR-4202	DELCO REMY	1114906 [8]	STR-4200
DELCO REMY	1114175 [8]	STR-4202	DELCO REMY	1114834 [8]	STR-4202	DELCO REMY	1114911 [8]	STR-4202
DELCO REMY	1114187 [17]	STR-4200	DELCO REMY	1114842 [17]	STR-4302	DELCO REMY	1114913 [17]	STR-4200
DELCO REMY	1114187 [8]	STR-4200	DELCO REMY	1114842 [8]	STR-4302	DELCO REMY	1114913 [8]	STR-4200
DELCO REMY	1114190 [8]	STR-4202	DELCO REMY	1114843 [17]	STR-4303	DELCO REMY	1114915 [17]	STR-4302
DELCO REMY	1114193 [17]	STR-4200	DELCO REMY	1114843 [8]	STR-4303	DELCO REMY	1114915 [8]	STR-4302
DELCO REMY	1114193 [8]	STR-4200	DELCO REMY	1114845 [17]	STR-4303	DELCO REMY	1114916 [17]	STR-4302
DELCO REMY	1114194 [17]	STR-4200	DELCO REMY	1114845 [8]	STR-4303	DELCO REMY	1114916 [8]	STR-4302
DELCO REMY	1114194 [8]	STR-4200	DELCO REMY	1114846 [17]	STR-4302	DELCO REMY	1114917 [17]	STR-4303
DELCO REMY	1114197 [17]	STR-4200	DELCO REMY	1114846 [8]	STR-4302	DELCO REMY	1114917 [8]	STR-4303
DELCO REMY	1114197 [8]	STR-4200	DELCO REMY	1114848 [17]	STR-4302	DELCO REMY	1114923 [17]	STR-4302
DELCO REMY	1114198 [8]	STR-4202	DELCO REMY	1114848 [8]	STR-4302	DELCO REMY	1114923 [8]	STR-4302
DELCO REMY	1114700 [17]	STR-4200	DELCO REMY	1114849 [17]	STR-4302	DELCO REMY	1114928 [17]	STR-4200
DELCO REMY	1114700 [8]	STR-4200	DELCO REMY	1114849 [8]	STR-4302	DELCO REMY	1114928 [8]	STR-4200
DELCO REMY	1114704 [8]	STR-4202	DELCO REMY	1114850 [17]	STR-4302	DELCO REMY	1114933 [8]	STR-4202
DELCO REMY	1114705 [8]	STR-4202	DELCO REMY	1114850 [8]	STR-4302	DELCO REMY	1114935 [17]	STR-4302
DELCO REMY	1114706 [17]	STR-4303	DELCO REMY	1114851 [17]	STR-4302	DELCO REMY	1114935 [8]	STR-4302
DELCO REMY	1114706 [8]	STR-4303	DELCO REMY	1114851 [8]	STR-4302	DELCO REMY	1114937 [17]	STR-4200
DELCO REMY	1114708 [8]	STR-4202	DELCO REMY	1114854 [17]	STR-4302	DELCO REMY	1114937 [8]	STR-4200
DELCO REMY	1114709 [8]	STR-4202	DELCO REMY	1114854 [8]	STR-4302	DELCO REMY	1114941 [17]	STR-4200
DELCO REMY	1114711 [17]	STR-4303	DELCO REMY	1114856 [17]	STR-4303	DELCO REMY	1114941 [8]	STR-4200
DELCO REMY	1114711 [8]	STR-4303	DELCO REMY	1114856 [8]	STR-4303	DELCO REMY	1114963 [17]	STR-4302
DELCO REMY	1114715 [17]	STR-4302	DELCO REMY	1114857 [17]	STR-4303	DELCO REMY	1114963 [8]	STR-4302
DELCO REMY	1114715 [8]	STR-4302	DELCO REMY	1114857 [8]	STR-4303	DELCO REMY	1114964 [17]	STR-4302
DELCO REMY	1114720 [17]	STR-4200	DELCO REMY	1114862 [17]	STR-4303	DELCO REMY	1114964 [8]	STR-4302
DELCO REMY	1114720 [8]	STR-4200	DELCO REMY	1114862 [8]	STR-4303	DELCO REMY	1114966 [8]	STR-4202
DELCO REMY	1114722 [17]	STR-4200	DELCO REMY	1114872 [17]	STR-4303	DELCO REMY	1114967 [8]	STR-4202
DELCO REMY	1114722 [8]	STR-4200	DELCO REMY	1114872 [8]	STR-4303	DELCO REMY	1114984 [17]	STR-4200
DELCO REMY	1114724 [8]	STR-4202	DELCO REMY	1114873 [17]	STR-4302	DELCO REMY	1114984 [8]	STR-4200
DELCO REMY	1114725 [17]	STR-4200	DELCO REMY	1114873 [8]	STR-4302	DELCO REMY	1114985 [17]	STR-4200
DELCO REMY	1114725 [8]	STR-4200	DELCO REMY	1114874 [17]	STR-4302	DELCO REMY	1114985 [8]	STR-4200
DELCO REMY	1114728 [17]	STR-4302	DELCO REMY	1114874 [8]	STR-4302	DELCO REMY	1114986 [17]	STR-4202
DELCO REMY	1114728 [8]	STR-4302	DELCO REMY	1114875 [17]	STR-4302	DELCO REMY	1114987 [17]	STR-4302
DELCO REMY	1114737 [17]	STR-4302	DELCO REMY	1114875 [8]	STR-4302	DELCO REMY	1114987 [8]	STR-4302
DELCO REMY	1114737 [8]	STR-4302	DELCO REMY	1114878 [17]	STR-4302	DELCO REMY	1114989 [17]	STR-4303
DELCO REMY	1114746 [8]	STR-4202	DELCO REMY	1114878 [8]	STR-4302	DELCO REMY	1114989 [8]	STR-4303
DELCO REMY	1114747 [17]	STR-4200	DELCO REMY	1114879 [17]	STR-4302	DELCO REMY	1117841 [2]	ALT-1004
DELCO REMY	1114747 [8]	STR-4200	DELCO REMY	1114879 [8]	STR-4302	DELCO REMY	1117882 [2]	ALT-1004
DELCO REMY	1114748 [8]	STR-4202	DELCO REMY	1114880 [17]	STR-4302	DELCO REMY	1117885 [2]	ALT-1002
DELCO REMY	1114753 [8]	STR-4202	DELCO REMY	1114880 [8]	STR-4302	DELCO REMY	1117886 [2]	ALT-1002
DELCO REMY	1114754 [8]	STR-4202	DELCO REMY	1114881 [8]	STR-4202	DELCO REMY	1117887 [2]	ALT-1002
DELCO REMY	1114756 [17]	STR-4302	DELCO REMY	1114882 [8]	STR-4202	DELCO REMY	1117890 [2]	ALT-1002
DELCO REMY	1114756 [8]	STR-4302	DELCO REMY	1114883 [8]	STR-4202	DELCO REMY	1117891 [2]	ALT-1004
DELCO REMY	1114761 [17]	STR-4200	DELCO REMY	1114885 [8]	STR-4202	DELCO REMY	1117892 [2]	ALT-1002
DELCO REMY	1114761 [8]	STR-4200	DELCO REMY	1114888 [8]	STR-4202	DELCO REMY	1117905 [2]	ALT-1002
DELCO REMY	1114762 [17]	STR-4302	DELCO REMY	1114889 [17]	STR-4200	DELCO REMY	1117906 [2]	ALT-1004
DELCO REMY	1114762 [8]	STR-4302	DELCO REMY	1114889 [8]	STR-4200	DELCO REMY	1117909 [2]	ALT-1004
DELCO REMY	1114765 [8]	STR-4202	DELCO REMY	1114890 [17]	STR-4200	DELCO REMY	1117910 [2]	ALT-1004
DELCO REMY	1114791 [8]	STR-4202	DELCO REMY	1114890 [8]	STR-4200	DELCO REMY	1117911 [2]	ALT-1004
DELCO REMY	1114802 [8]	STR-4202	DELCO REMY	1114891 [17]	STR-4200	DELCO REMY	1117914 [2]	ALT-1004
DELCO REMY	1114811 [17]	STR-4200	DELCO REMY	1114891 [8]	STR-4200	DELCO REMY	1117916 [2]	ALT-1002
DELCO REMY	1114811 [8]	STR-4200	DELCO REMY	1114892 [17]	STR-4200	DELCO REMY	1117917 [2]	ALT-1002
DELCO REMY	1114812 [17]	STR-4200	DELCO REMY	1114892 [8]	STR-4200	DELCO REMY	1117918 [2]	ALT-1004
DELCO REMY	1114812 [8]	STR-4200	DELCO REMY	1114893 [17]	STR-4200	DELCO REMY	1117919 [2]	ALT-1002
DELCO REMY	1114813 [17]	STR-4200	DELCO REMY	1114893 [8]	STR-4200	DELCO REMY	1117920 [2]	ALT-1002
DELCO REMY	1114813 [8]	STR-4200	DELCO REMY	1114894 [17]	STR-4200	DELCO REMY	1117921 [2]	ALT-1002
DELCO REMY	1114814 [17]	STR-4200	DELCO REMY	1114894 [8]	STR-4200	DELCO REMY	1117922 [2]	ALT-1002
DELCO REMY	1114814 [8]	STR-4200	DELCO REMY	1114895 [17]	STR-4200	DELCO REMY	1117923 [2]	ALT-1004
DELCO REMY	1114815 [17]	STR-4200	DELCO REMY	1114895 [8]	STR-4200	DELCO REMY	1117924 [2]	ALT-1002
DELCO REMY	1114815 [8]	STR-4200	DELCO REMY	1114896 [17]	STR-4200	DELCO REMY	1117929 [2]	ALT-1004
DELCO REMY	1114816 [17]	STR-4200	DELCO REMY	1114896 [8]	STR-4200	DELCO REMY	1117932 [2]	ALT-1004
DELCO REMY	1114816 [8]	STR-4200	DELCO REMY	1114897 [17]	STR-4200	DELCO REMY	1117933 [2]	ALT-1002

*See page 43 for all footnotes

INTERCHANGE DATA

Manufacturer	OEM Part #	Meritor	Manufacturer	OEM Part #	Meritor	Manufacturer	OEM Part #	Meritor
DELCO REMY	1117934 [2]	ALT-1002	DELCO REMY	1998481 [4]	STR-7054	DENSO	228000-1982	STR-5001
DELCO REMY	1117937 [2]	ALT-1002	DELCO REMY	1998490 [4]	STR-7051	DENSO	228000-1983	STR-5001
DELCO REMY	1117943 [2]	ALT-1004	DENSO	028000-1850	STR-3571	DENSO	228000-4670	STR-6090
DELCO REMY	1117946 [2]	ALT-1004	DENSO	028000-2150	STR-3571	DENSO	228000-4671	STR-6090
DELCO REMY	1117947 [2]	ALT-1004	DENSO	028000-2151	STR-3571	DENSO	228000-5310	STR-9051
DELCO REMY	1117948 [2]	ALT-1002	DENSO	028000-2240	STR-3571	DENSO	228000-5311	STR-9051
DELCO REMY	1117949 [2]	ALT-1004	DENSO	028000-2241	STR-3571	DENSO	228000-5850	STR-9050
DELCO REMY	1117951 [2]	ALT-1004	DENSO	028000-2692	STR-3571	DENSO	228000-5851	STR-9050
DELCO REMY	1117952 [2]	ALT-1002	DENSO	028000-3800	STR-3571	DENSO	228000-6950	STR-5021
DELCO REMY	1117957 [2]	ALT-1004	DENSO	028000-3830	STR-3571	DENSO	228000-6951	STR-5021
DELCO REMY	1117958 [2]	ALT-1004	DENSO	028000-5050	STR-6001	DENSO	228000-6952	STR-5021
DELCO REMY	1117959 [2]	ALT-1004	DENSO	028000-5060	STR-5001	DENSO	228000-6980	STR-6099
DELCO REMY	1117961 [2]	ALT-1004	DENSO	028000-5290	STR-3571	DENSO	228000-6980	STR-6090
DELCO REMY	1117962 [2]	ALT-1004	DENSO	028000-5740	STR-3571	DENSO	228000-6981	STR-6099
DELCO REMY	1117963 [2]	ALT-1004	DENSO	028000-5880	STR-6052	DENSO	228000-6981	STR-6090
DELCO REMY	1117964 [2]	ALT-1002	DENSO	028000-5881	STR-6052	DENSO	228000-6981	STR-6090
DELCO REMY	1117966 [2]	ALT-1004	DENSO	028000-5882	STR-6052	DENSO	228000-8410	STR-6052
DELCO REMY	15754097A	ALT-1511	DENSO	028000-5883	STR-6052	DENSO	228000-8420 [10]	STR-7006
DELCO REMY	15754097M	ALT-1511	DENSO	028000-5884	STR-6052	DENSO	228000-9100	STR-6090
DELCO REMY	15754097W	ALT-1511	DENSO	028000-6440	STR-5001	DENSO	428000-0930	STR-5300
DELCO REMY	19010102 [2]	ALT-1002	DENSO	028000-6441	STR-5001	DENSO	428000-0931	STR-5300
DELCO REMY	19010103 [2]	ALT-1002	DENSO	028000-7000	STR-5001	DENSO	428000-1210 [16]	STR-4290
DELCO REMY	19010104 [2]	ALT-1004	DENSO	028000-7001	STR-5001	DENSO	428000-1210 [7]	STR-4290
DELCO REMY	19010105 [2]	ALT-1002	DENSO	028000-7001	STR-5001	DENSO	428000-1211 [16]	STR-4290
DELCO REMY	19010114 [2]	ALT-1002	DENSO	028000-7002	STR-5001	DENSO	428000-1211 [7]	STR-4290
DELCO REMY	19010120 [2]	ALT-1004	DENSO	028000-7003	STR-5001	DENSO	428000-1220 [16]	STR-4290
DELCO REMY	19010124 [2]	ALT-1004	DENSO	028000-7004	STR-5001	DENSO	428000-1220 [7]	STR-4290
DELCO REMY	19010125 [2]	ALT-1004	DENSO	028000-8890	STR-3571	DENSO	428000-1221 [16]	STR-4290
DELCO REMY	19010126 [2]	ALT-1002	DENSO	028000-9760	STR-6170	DENSO	428000-1221 [7]	STR-4290
DELCO REMY	19010127 [2]	ALT-1002	DENSO	128000-0021	STR-5001	DENSO	428000-1450 [16]	STR-4390
DELCO REMY	19010129 [2]	ALT-1004	DENSO	128000-0022	STR-5001	DENSO	428000-1450 [7]	STR-4390
DELCO REMY	19010134 [2]	ALT-1004	DENSO	128000-0210	STR-6090	DENSO	428000-1451 [16]	STR-4390
DELCO REMY	19010137 [2]	ALT-1004	DENSO	128000-0211	STR-6090	DENSO	428000-1451 [7]	STR-4390
DELCO REMY	19010138 [2]	ALT-1002	DENSO	128000-0212	STR-6090	DENSO	428000-1451 [7]	STR-4390
DELCO REMY	19010145 [2]	ALT-1004	DENSO	128000-0213	STR-6090	DENSO	428000-4420 [16]	STR-4292
DELCO REMY	19010147 [2]	ALT-1004	DENSO	128000-0213	STR-6090	DENSO	428000-4420 [7]	STR-4292
DELCO REMY	19010153 [2]	ALT-1004	DENSO	128000-0214	STR-6090	DENSO	428000-4430 [16]	STR-4292
DELCO REMY	19010153 [2]	ALT-1004	DENSO	128000-0214	STR-6090	DENSO	428000-4430 [7]	STR-4292
DELCO REMY	19010155 [2]	ALT-1004	DENSO	128000-0215	STR-6090	DENSO	428000-4430 [7]	STR-4292
DELCO REMY	19010156 [2]	ALT-1002	DENSO	128000-0215	STR-6090	DENSO	428000-4440 [16]	STR-4292
DELCO REMY	19010161 [2]	ALT-1004	DENSO	128000-0216	STR-6090	DENSO	428000-4440 [7]	STR-4292
DELCO REMY	19010162 [2]	ALT-1004	DENSO	128000-0540	STR-6090	DENSO	428000-4450 [7]	STR-4293
DELCO REMY	19010163 [2]	ALT-1004	DENSO	128000-0541	STR-6090	DENSO	428000-5190 [16]	STR-4292
DELCO REMY	19010168 [2]	ALT-1002	DENSO	128000-0542	STR-6090	DENSO	428000-5190 [7]	STR-4292
DELCO REMY	19010171 [2]	ALT-1004	DENSO	128000-0543	STR-6090	DENSO	428000-5430 [7]	STR-4295
DELCO REMY	19010173 [2]	ALT-1004	DENSO	128000-0544	STR-6090	DENSO	428000-5430 [7]	STR-4295
DELCO REMY	19010174 [2]	ALT-1004	DENSO	128000-1340 [17]	STR-4200	DENSO	428000-5730 [16]	STR-4292
DELCO REMY	19010176 [2]	ALT-1004	DENSO	128000-1340 [8]	STR-4200	DENSO	428000-5730 [7]	STR-4292
DELCO REMY	19010178 [2]	ALT-1004	DENSO	128000-2270	STR-6090	DENSO	9702809-588	STR-6052
DELCO REMY	19010181 [2]	ALT-1002	DENSO	128000-2271	STR-6090	DENSO	9712809-021	STR-6090
DELCO REMY	19010182 [2]	ALT-1002	DENSO	128000-2273	STR-6090	DENSO	9712809-134 [17]	STR-4200
DELCO REMY	19010192 [2]	ALT-1002	DENSO	128000-2273	STR-6090	DENSO	9712809-134 [8]	STR-4200
DELCO REMY	19010196 [2]	ALT-1004	DENSO	128000-2480	STR-6090	DENSO	9712809-950	STR-6090
DELCO REMY	19011002 [2]	ALT-1002	DENSO	128000-3120	STR-6090	DENSO	9722809-585	STR-9050
DELCO REMY	19011003 [2]	ALT-1002	DENSO	128000-3121	STR-6090	DENSO	9722809-585	STR-9050
DELCO REMY	19011921 [11]	STR-7005	DENSO	128000-3122	STR-6090	DENSO	LAY428000-0070 [16]	STR-4390
DELCO REMY	1990220 [8]	STR-4202	DENSO	128000-3123	STR-6090	DENSO	LAY428000-0070 [7]	STR-4390
DELCO REMY	1990221 [8]	STR-4202	DENSO	128000-7510 [17]	STR-4303	DETROIT DIESEL	R0459111 [2]	ALT-1004
DELCO REMY	1990290 [8]	STR-4202	DENSO	128000-7510 [8]	STR-4303	DETROIT DIESEL	R0459133 [2]	ALT-1002
DELCO REMY	1990304 [8]	STR-4202	DENSO	128000-7520 [17]	STR-4303	DETROIT DIESEL	R0459135 [2]	ALT-1004
DELCO REMY	1993703 [8]	STR-4202	DENSO	128000-7520 [8]	STR-4303	DETROIT DIESEL	R0459139 [12]	ALT-0050
DELCO REMY	1993846 [17]	STR-4303	DENSO	128000-9500	STR-6090	DETROIT DIESEL	R0459140 [12]	ALT-0050
DELCO REMY	1993846 [8]	STR-4303	DENSO	128000-9501	STR-6090	DETROIT DIESEL	R0459152 [2]	ALT-1004
DELCO REMY	1998336 [4]	STR-7054	DENSO	128000-9502	STR-6090	DETROIT DIESEL	R0461125	STR-4250
DELCO REMY	1998346 [4]	STR-7072	DENSO	128000-9503	STR-6090	DETROIT DIESEL	R0461126	STR-4200
DELCO REMY	1998367 [4]	STR-7072	DENSO	228000-0070 [17]	STR-4303	DETROIT DIESEL	R0461127	STR-4200
DELCO REMY	1998383 [4]	STR-7054	DENSO	228000-0070 [8]	STR-4303	DETROIT DIESEL	R0461180	ALT-1004
DELCO REMY	1998387 [4]	STR-7054	DENSO	228000-0620	STR-6090	DETROIT DIESEL	R0461185	STR-4208
DELCO REMY	1998401 [4]	STR-7055	DENSO	228000-0621	STR-6090	DETROIT DIESEL	R0461185	STR-4208
DELCO REMY	1998408 [4]	STR-7051	DENSO	228000-0622	STR-6090	DETROIT DIESEL	R0461446	STR-7054
DELCO REMY	1998423 [4]	STR-7051	DENSO	228000-0623	STR-6090	DETROIT DIESEL	R0465406	STR-7054
DELCO REMY	1998442 [4]	STR-7055	DENSO	228000-0623	STR-6090	DETROIT DIESEL	R0465407	STR-7051
DELCO REMY	1998456 [4]	STR-7051	DENSO	228000-1950	STR-6090	FORD	2C2411000AA	STR-7012
DELCO REMY	1998457 [4]	STR-7051	DENSO	228000-1951	STR-6090	FORD	2C3T11000AA	STR-7012
			DENSO	228000-1952	STR-6090	FORD	2C3Z11002AA	STR-7012
			DENSO	228000-1953	STR-6090	FORD	3C3U11000AB	STR-7013
			DENSO	228000-1980	STR-5001	FORD	3C3U11000AC	STR-7013
			DENSO	228000-1981	STR-5001	FORD	3C3Z11002AA	STR-7013

INTERCHANGE DATA

Manufacturer	OEM Part #	Meritor	Manufacturer	OEM Part #	Meritor	Manufacturer	OEM Part #	Meritor
FORD	4C4011001CA	STR-0142	FORD	F2HS10346CA	ALT-0050	FORD	GL-189 [12]	ALT-0050
FORD	4C4Z10346FA	ALT-1003	FORD	F3HT10300DA [2]	ALT-1004	FORD	GL-189A [12]	ALT-0050
FORD	4C4Z10346GA	ALT-1003	FORD	F3HT10300EA [2]	ALT-1004	FORD	GL-208 [12]	ALT-0050
FORD	4C4Z11002CA	STR-0142	FORD	F3HT10300FA [2]	ALT-1004	FORD	GL-333 [2]	ALT-1004
FORD	C4TF11000A [17]	STR-4302	FORD	F3HT11001AB	STR-7075	FORD	GL-336 [2]	ALT-1004
FORD	C4TF11000A [8]	STR-4302	FORD	F3HT11001AC	STR-7075	FORD	GL-359 [2]	ALT-1004
FORD	C4TZ11002A [17]	STR-4302	FORD	F3HT11001DB	STR-7056	FORD	GL-364 [2]	ALT-1004
FORD	C4TZ11002A [8]	STR-4302	FORD	F3HT11001DC	STR-7056	FORD	GL-365 [2]	ALT-1004
FORD	C5TF11000A [17]	STR-4200	FORD	F3HZ10346E [2]	ALT-1004	FORD	GL-366 [2]	ALT-1002
FORD	C5TF11000A [8]	STR-4200	FORD	F3HZ10346J [2]	ALT-1004	FORD	GL-393 [12]	ALT-0050
FORD	C5TZ11002C [17]	STR-4200	FORD	F3HZ11002A	STR-7075	FORD	GL-394 [12]	ALT-0050
FORD	C5TZ11002C [8]	STR-4200	FORD	F3HZ11002B	STR-7056	FORD	GL-397 [12]	ALT-0050
FORD	C6TF11000A [17]	STR-4200	FORD	F3MZ11002A	STR-7075	FORD	GL-398 [12]	ALT-0050
FORD	C6TF11000A [8]	STR-4200	FORD	F3TF11000AA [11]	STR-7005	FORD	SA-655 [8]	STR-4202
FORD	C6TF11000C [17]	STR-4200	FORD	F3TU11000AA [11]	STR-7005	FORD	SA-655B [8]	STR-4202
FORD	C6TF11000C [8]	STR-4200	FORD	F3TZ11002B [11]	STR-7005	FORD	SA-655C [8]	STR-4202
FORD	C6TZ11002E [17]	STR-4200	FORD	F4HT10300GA [2]	ALT-1004	FORD	SA-655D [8]	STR-4202
FORD	C6TZ11002E [8]	STR-4200	FORD	F4HT10300HA [2]	ALT-1004	FORD	SA-689 [17]	STR-4200
FORD	C8TF11000B [17]	STR-4200	FORD	F4HT10300JA [2]	ALT-1004	FORD	SA-689 [8]	STR-4200
FORD	C8TF11000B [8]	STR-4200	FORD	F4HT10300LA [2]	ALT-1004	FORD	SA-690 [17]	STR-4200
FORD	C8TF11000C [8]	STR-4202	FORD	F4HT11001AA	STR-7075	FORD	SA-690 [8]	STR-4200
FORD	C8TZ11002A [17]	STR-4200	FORD	F4PU11000AA	STR-7005	FORD	SA-696 [8]	STR-4202
FORD	C8TZ11002A [8]	STR-4200	FORD	F4PU11000AC	STR-7005	FORD	SA-721	STR-4250
FORD	C8TZ11002B [8]	STR-4202	FORD	F4TZ11002A	STR-7006	FORD	SA-736 [8]	STR-4202
FORD	D3TF11001BA [17]	STR-4200	FORD	F4TZ11002B	STR-7005	FORD	SA-739A [11]	STR-7005
FORD	D3TF11001BA [8]	STR-4200	FORD	F5HZ10346B [2]	ALT-1004	FORD	SA-739B [11]	STR-7005
FORD	D4HF11000CA [8]	STR-4202	FORD	F5TU11000AA	STR-7006	FORD	SA-744	STR-4250
FORD	D4HZ10346N [12]	ALT-0050	FORD	F5TU11000AB	STR-7006	FORD	SA-745	STR-4250
FORD	D4HZ11002C [8]	STR-4202	FORD	F5TU11000AD	STR-7006	FORD	SA-747	STR-4250
FORD	D4TZ11002A [17]	STR-4200	FORD	F6HT10300BA [2]	ALT-1004	FORD	SA-756	STR-4200
FORD	D4TZ11002A [8]	STR-4200	FORD	F6HT10300CA [2]	ALT-1004	FORD	SA-756A	STR-4200
FORD	D4TZ11002B [17]	STR-4200	FORD	F6HT10300FA [2]	ALT-1002	FORD	SA-757	STR-4202
FORD	D4TZ11002B [8]	STR-4200	FORD	F6HT110001AA	STR-4200	FORD	SA-768A	STR-4209
FORD	D4TZ11002E [8]	STR-4202	FORD	F6HT110001BA	STR-4209	FORD	SA-778	STR-4200
FORD	D4TZ11002F [8]	STR-4202	FORD	F6HT11001DA	STR-4206	FORD	SA-796	STR-4200
FORD	D7HS10346AA [12]	ALT-0060	FORD	F6HT11001EA	STR-4303	FORD	SA-802	STR-7075
FORD	D7HT10300CA [12]	ALT-0050	FORD	F6HT11001FA	STR-4210	FORD	SA-803	STR-7056
FORD	D7HT10300DA [12]	ALT-0050	FORD	F6HT11001GA	STR-4200	FORD	SA-817	STR-7006
FORD	D7HT10300EA [12]	ALT-0050	FORD	F6HT11001HA	STR-4201	FORD	SA-819	STR-7005
FORD	D8HZ10346B [12]	ALT-0050	FORD	F6HZ10346A [2]	ALT-1004	FORD	SA-823	STR-4200
FORD	D8HZ10346C [12]	ALT-0050	FORD	F6HZ10346B [2]	ALT-1004	FORD	SA-824	STR-4209
FORD	D8HZ11002C	STR-4250	FORD	F6HZ10346C [2]	ALT-1002	FORD	SA-826	STR-4206
FORD	D9PZ11002A [8]	STR-4202	FORD	F6HZ11002AA	STR-4200	FORD	SA-827	STR-4303
FORD	E2HZ11002A [8]	STR-4202	FORD	F6HZ11002BA	STR-4209	FORD	SA-828	STR-4210
FORD	E3HS10346BA [12]	ALT-0060	FORD	F6HZ11002DA	STR-4206	FORD	SA-829	STR-4200
FORD	E3HZ11002A	STR-4250	FORD	F6HZ11002EA	STR-4303	FORD	SA-835	STR-4201
FORD	E3HZ11002B	STR-4250	FORD	F6HZ11002FA	STR-4210	FORD	SA-845	STR-4201
FORD	E3HZ11002C	STR-4250	FORD	F6HZ11002GA	STR-4200	FORD	SA-900	STR-7012
FORD	E3TU11000AA [11]	STR-7005	FORD	F6HZ11002HA	STR-4201	FORD	SA-903	STR-7012
FORD	E5TF11000AA [11]	STR-7005	FORD	F7HS10300AA	ALT-3632	FORD	SA-904	STR-7013
FORD	E5TZ11002B [11]	STR-7005	FORD	F7HT10300AA [12]	ALT-0050	FORD	SA-922	STR-0142
FORD	E6HT11001AA	STR-4202	FORD	F7HT10300BA [12]	ALT-0050	FORD	SAE-739B [11]	STR-7005
FORD	E6HT11001CA	STR-4200	FORD	F7HT10300EA [12]	ALT-0050	FORD	SAE-819	STR-7005
FORD	E6HZ11002A [8]	STR-4202	FORD	F7HT10300GA [12]	ALT-0050	FREIGHTLINER	110-573	ALT-0060
FORD	E6HZ11002B [8]	STR-4202	FORD	F7HT10300HA [12]	ALT-0050	FREIGHTLINER	FL0379 [7]	STR-4293
FORD	E6HZ11002BA	STR-4202	FORD	F7HT11001DA	STR-4201	FREIGHTLINER	FL0579 [7]	STR-4292
FORD	E6HZ11002C	STR-4200	FORD	F7HZ10346AA [12]	ALT-0050	FREIGHTLINER	LN110555	ALT-0050
FORD	E6HZ11002D	STR-4200	FORD	F7HZ10346BA [12]	ALT-0050	FREIGHTLINER	LN110777	ALT-0050
FORD	E8HT11001AA	STR-4209	FORD	F7HZ10346GA [12]	ALT-0050	FREIGHTLINER	LN2500J [12]	ALT-0050
FORD	E8HZ10346J [12]	ALT-0050	FORD	F7HZ10346HA [12]	ALT-0050	FREIGHTLINER	LN2526J [12]	ALT-0050
FORD	E8HZ10346K [12]	ALT-0050	FORD	F7HZ11002CA	STR-4200	FREIGHTLINER	LN2600J [12]	ALT-0050
FORD	E8HZ11002A	STR-4209	FORD	F7HZ11002D	STR-4201	FREIGHTLINER	LN2670J [12]	ALT-0050
FORD	E8HZ11002FA	STR-4210	FORD	F7HZ11002DA	STR-4201	FREIGHTLINER	LN2700J [12]	ALT-0050
FORD	E8HZ11002HA	STR-4209	FORD	IC3U11000AA	STR-7012	FREIGHTLINER	LN2800J [12]	ALT-0060
FORD	E8TF11000AA [11]	STR-7005	FORD	IC3U11000AB	STR-7012	FREIGHTLINER	LN2805J [12]	ALT-0060
FORD	E8TZ11002A [11]	STR-7005	FORD	IC3U11000AC	STR-7012	FREIGHTLINER	LN2824J [5]	ALT-1282
FORD	E9HT10300BA [12]	ALT-0050	FORD	IC3U11000AD	STR-7012	FREIGHTLINER	LN2824L [5]	ALT-1282
FORD	FOHT11001AA	STR-4200	FORD	IC3U11000AE	STR-7012	FREIGHTLINER	LN4830LC [12]	ALT-0070
FORD	FOHT11001AB	STR-4200	FORD	IC3Z11002AA	STR-7012	FREIGHTLINER	LN4939PGH [5]	ALT-1280
FORD	FOHZ11002A	STR-4200	FORD	GL-187 [12]	ALT-0050	FREIGHTLINER	LN-7400MC [8]	STR-4302
FORD	F1HT11001AA	STR-4200	FORD	GL-188 [12]	ALT-0050	FREIGHTLINER	MIB97059 [7]	STR-4292
FORD	F1HZ11002A	STR-4200	FORD	GL-188A [12]	ALT-0050	FREIGHTLINER	MIB97059FL [7]	STR-4292

*See page 43 for all footnotes

INTERCHANGE DATA

Manufacturer	OEM Part #	Meritor	Manufacturer	OEM Part #	Meritor	Manufacturer	OEM Part #	Meritor
HINO	28100-1490A [9]	STR-9109	INTERNATIONAL	439677R91 [8]	STR-4302	ISUZU	8-97183-913-0	STR-6006
HINO	28100-1491A [9]	STR-9109	INTERNATIONAL	462588C91	STR-4250	ISUZU	8-97228-664-0	STR-6006
HINO	28100-1492 [9]	STR-9109	INTERNATIONAL	489716C91	STR-4302	JOHN DEERE	AM108722	STR-5001
HINO	28100-1493 [9]	STR-9109	INTERNATIONAL	489717C91	STR-4250	JOHN DEERE	GV11567	STR-5001
HINO	28100-1542 [9]	STR-6170	INTERNATIONAL	510275C91 [8]	STR-4200	KASSBOHRER	7-421-333-000	ALT-T145
HINO	28100-1542A [9]	STR-6170	INTERNATIONAL	513303C91 [12]	ALT-0050	KASSBOHRER	7-421-336-000	ALT-T145
HINO	28100-1542B [9]	STR-6170	INTERNATIONAL	513542C91 [12]	ALT-0050	KASSBOHRER	7-421-341-000	ALT-0110
HINO	28100-1542C [9]	STR-6170	INTERNATIONAL	514089C91 [12]	ALT-0050	KASSBOHRER	7-421-347-000	ALT-0102
HINO	28100-1543 [9]	STR-6170	INTERNATIONAL	522458C91 [8]	STR-4200	KASSBOHRER	7-421-353-000	ALT-0110
HINO	28100-1543A [9]	STR-6170	INTERNATIONAL	523579C91 [8]	STR-4200	KASSBOHRER	7-421-354-000	ALT-T145
HINO	28100-1543B [9]	STR-6170	INTERNATIONAL	527888C91	STR-4302	KASSBOHRER	7-421-355-000	ALT-T150
HINO	28100-1644 [9]	STR-9109	INTERNATIONAL	527890C91 [12]	ALT-0060	KASSBOHRER	7-431-021-000	STR-2391
HINO	28100-1645A [9]	STR-9109	INTERNATIONAL	530692C91 [8]	STR-4200	KASSBOHRER	7-431-026-000	STR-2380
HINO	28100-1680 [8]	STR-4200	INTERNATIONAL	547269C91 [12]	ALT-0060	KASSBOHRER	7-431-031-000	STR-2380
HINO	28100-1680A [8]	STR-4200	INTERNATIONAL	585945C91 [12]	ALT-0050	KENWORTH	K371-115-1	ALT-0060
HINO	28100-1790 [9]	STR-9109	INTERNATIONAL	585946C91 [12]	ALT-0050	KENWORTH	K371-124-1 [12]	ALT-0050
HINO	28100-1791 [9]	STR-9109	INTERNATIONAL	585947C91 [12]	ALT-0050	KHD	0118-2405	ALT-2117A
HINO	28100-1881 [9]	STR-6170	INTERNATIONAL	585948C91 [12]	ALT-0060	KHD	0118-2771	ALT-2117A
HITACHI	S114-290	STR-6001	INTERNATIONAL	590071C91 [2]	ALT-1004	KHD	117-8511	ALT-0102
HITACHI	S12-41	STR-6001	INTERNATIONAL	597219C91	STR-4202	KUBOTA	16225-63013	STR-3571
HITACHI	S12-89	STR-6006	INTERNATIONAL	597220C91	STR-4202	KUBOTA	19007-63011	STR-3571
HITACHI	S13-207C	STR-6009	INTERNATIONAL	599102C91 [8]	STR-4202	KUBOTA	19460-63011	STR-5021
HITACHI	S13-211	STR-6006	INTERNATIONAL	627589C91 [8]	STR-4302	KUBOTA	19460-63012	STR-5021
HITACHI	S13-289	STR-6006	INTERNATIONAL	673782C91 [8]	STR-4303	KUBOTA	19460-63013	STR-5021
HITACHI	S13-289A	STR-6006	INTERNATIONAL	673796C92	STR-4202	KUBOTA	19637-63013	STR-3571
HITACHI	S13-289B	STR-6006	INTERNATIONAL	690400C91 [8]	STR-4302	KUBOTA	19837-63010	STR-3571
HITACHI	S13-289C	STR-6006	INTERNATIONAL	690644C92 [8]	STR-4303	KUBOTA	19837-63013	STR-3571
HITACHI	S13-84	STR-6001	INTERNATIONAL	739911C91	STR-4250	KUBOTA	1G911-63012	STR-5300
HITACHI	S13-84A	STR-6001	INTERNATIONAL	739912C91	STR-4250	LESTER	3285	STR-4200
HITACHI	S13-84B	STR-6001	INTERNATIONAL	755496C91 [8]	STR-4302	LESTER	3840	STR-4251
HITACHI	S13-89	STR-6006	INTERNATIONAL	777525C91 [8]	STR-4200	LESTER	3872	STR-4251
HITACHI	S13-89A	STR-6006	INTERNATIONAL	782685C91 [8]	STR-4200	LESTER	3883	STR-4251
HITACHI	S13-89B	STR-6006	INTERNATIONAL	786086C91 [8]	STR-4200	LESTER	4600	STR-4250
HITACHI	S13-89C	STR-6006	INTERNATIONAL	789355C1 [8]	STR-4202	LESTER	4736	STR-4200
HITACHI	S13-89D	STR-6006	INTERNATIONAL	875755R91 [8]	STR-4200	LESTER	4782	STR-4202
INTERNATIONAL	1258304C1	ALT-0050	INTERNATIONAL	897593C1 [8]	STR-4202	LESTER	4917	STR-4250
INTERNATIONAL	1614303C91 [6]	STR-0121	INTERNATIONAL	897593C1 [8]	STR-4202	LESTER	4930	STR-4250
INTERNATIONAL	1618318C91 [12]	ALT-0060	INTERNATIONAL	989969C91 [8]	STR-4302	LESTER	4960	STR-7072
INTERNATIONAL	1664631C91 [12]	ALT-0050	INTERNATIONAL	989969R91 [8]	STR-4302	LESTER	4991	STR-4250
INTERNATIONAL	1664632C91 [12]	ALT-0050	INTERNATIONAL	998504R91 [2]	ALT-1004	LESTER	4991	STR-4250
INTERNATIONAL	1664633C91 [12]	ALT-0050	INTERNATIONAL	LMN105302 [6]	STR-0121	LESTER	6225	STR-4202
INTERNATIONAL	1664634C91 [12]	ALT-0060	INTERNATIONAL	ZLMN105302 [6]	STR-0121	LESTER	6243	STR-4200
INTERNATIONAL	1677975C92 [2]	ALT-1002	INTERNATIONAL	ZLN110573	ALT-0060	LESTER	6243	STR-4202
INTERNATIONAL	1677976C2 [2]	ALT-1004	INTERNATIONAL	ZLN2670LC [12]	ALT-0050	LESTER	6251	STR-4206
INTERNATIONAL	1680754C92 [2]	ALT-1002	INTERNATIONAL	ZLN2800LC [12]	ALT-0060	LESTER	6253	STR-4202
INTERNATIONAL	1987586C1	STR-6090	INTERNATIONAL	ZLN4830LC [12]	ALT-0070	LESTER	6352	STR-4200
INTERNATIONAL	2011457C91 [6]	STR-0121	INTERNATIONAL	ZLN4836LGH [5]	ALT-1282	LESTER	6356	STR-4200
INTERNATIONAL	2018380C91 [6]	STR-0121	INTERNATIONAL	ZLNS4000 [8]	STR-4200	LESTER	6360	STR-4303
INTERNATIONAL	2018381C91 [6]	STR-0121	ISUZU	5-81100-086-0	STR-5001	LESTER	6361	STR-4303
INTERNATIONAL	2508914C91	STR-7005	ISUZU	5-81100-087-0	STR-5001	LESTER	6363	STR-4304
INTERNATIONAL	2585259C91	STR-6099	ISUZU	5-81100-103-0	STR-6001	LESTER	6364	STR-4302
INTERNATIONAL	260493C91	STR-4302	ISUZU	5-81100-155-0	STR-5001	LESTER	6366	STR-4200
INTERNATIONAL	262762C91 [8]	STR-4200	ISUZU	5-81100-166-0	STR-5001	LESTER	6370	STR-4302
INTERNATIONAL	263819C91	STR-4200	ISUZU	5-81100-166-1	STR-5001	LESTER	6371	STR-4202
INTERNATIONAL	293804C91 [8]	STR-4202	ISUZU	5-81100-166-2	STR-5001	LESTER	6372	STR-4202
INTERNATIONAL	307822R92 [8]	STR-4302	ISUZU	5-81100-166-3	STR-5001	LESTER	6378	STR-4302
INTERNATIONAL	313979R92	STR-4302	ISUZU	5-81100-166-4	STR-5001	LESTER	6450	STR-7051
INTERNATIONAL	313979R93	STR-4302	ISUZU	5-81100-183-1	STR-5001	LESTER	6469	STR-7055
INTERNATIONAL	317941R92 [8]	STR-4302	ISUZU	581100-186-0	STR-5001	LESTER	6508	STR-4302
INTERNATIONAL	3517125C91	ALT-1002	ISUZU	8-94115-565-0	STR-6001	LESTER	6511	STR-4207
INTERNATIONAL	3517186C91	ALT-1004	ISUZU	8-94123-387-0	STR-5001	LESTER	6513	STR-4209
INTERNATIONAL	3550644C92	ALT-1002	ISUZU	8-94123-870-0	STR-5001	LESTER	6517	STR-4202
INTERNATIONAL	3574171C91 [12]	ALT-0050	ISUZU	8-94147-549-2	STR-6006	LESTER	6525	STR-4202
INTERNATIONAL	3601668C91 [6]	STR-0121	ISUZU	8-94149-249-0	STR-6001	LESTER	6546	STR-4206
INTERNATIONAL	3815734C91 [7]	STR-4292	ISUZU	8-94199-249-0	STR-5001	LESTER	6548	STR-4201
INTERNATIONAL	412732C91 [8]	STR-4200	ISUZU	8-94412-730-0	STR-5001	LESTER	6552	STR-4305
INTERNATIONAL	415515C91	STR-4200	ISUZU	8-94422-997-0	STR-6006	LESTER	6553	STR-4304
INTERNATIONAL	423103C91 [2]	ALT-1004	ISUZU	8-94429-977-0	STR-6006	LESTER	6554	STR-4208
INTERNATIONAL	424430C91 [2]	ALT-1004	ISUZU	8-94429-977-1	STR-6006	LESTER	6555	STR-4207
INTERNATIONAL	430138C91	STR-4202	ISUZU	8-94429-977-2	STR-6006	LESTER	6566	STR-4210
INTERNATIONAL	431481C91 [8]	STR-4200	ISUZU	8-94429-978-0	STR-6001	LESTER	6570	STR-7072
INTERNATIONAL	431481R91 [8]	STR-4200	ISUZU	8-94448-959-1	STR-5001	LESTER	6573	STR-7051
INTERNATIONAL			ISUZU	897118-542-0	STR-6006	LESTER	6584	STR-7054

INTERCHANGE DATA

Manufacturer	OEM Part #	Meritor	Manufacturer	OEM Part #	Meritor	Manufacturer	OEM Part #	Meritor
LESTER	6585	STR-7056	LESTER	8096	ALT-3640	LESTER	12387	ALT-2110
LESTER	6595	STR-7075	LESTER	8097	ALT-3640	LESTER	12388	ALT-0114
LESTER	6669	STR-7012	LESTER	8274	ALT-1511	LESTER	12389	ALT-2111
LESTER	6670	STR-7013	LESTER	8292	ALT-1511	LESTER	12585	ALT-0102
LESTER	6801	STR-4290	LESTER	8329	ALT-0060	LESTER	12592	ALT-T145
LESTER	6802	STR-4290	LESTER	8332	ALT-0070	LESTER	12593	ALT-T145
LESTER	6803	STR-4391	LESTER	8360	ALT-1003	LESTER	12596	ALT-0113
LESTER	6804	STR-4290	LESTER	8361	ALT-1003	LESTER	12599	ALT-2117A
LESTER	6805	STR-4294	LESTER	8362	ALT-1003	LESTER	12606	ALT-T145
LESTER	6806	STR-4290	LESTER	8380	ALT-0050	LESTER	12607	ALT-T145
LESTER	6807	STR-0120	LESTER	8381	ALT-0060	LESTER	12608	ALT-T150
LESTER	6808	STR-0121	LESTER	8382	ALT-0050	LESTER	12610	ALT-T145
LESTER	6809	STR-0124	LESTER	8396	ALT-1282	LESTER	12612	ALT-T145
LESTER	6811	STR-4295	LESTER	8410	ALT-0051	LESTER	12615	ALT-T150
LESTER	6812	STR-4292	LESTER	8411	ALT-0051	LESTER	16658	STR-6052
LESTER	6814	STR-4290	LESTER	8505	ALT-1282	LESTER	16990	STR-6090
LESTER	6815	STR-4294	LESTER	8510	ALT-1282	LESTER	17040	STR-2050
LESTER	6816	STR-4294	LESTER	8574	ALT-3632	LESTER	17372	STR-6090
LESTER	6817	STR-4292	LESTER	8577	ALT-3641	LESTER	17394	STR-6090
LESTER	6818	STR-4293	LESTER	8578	ALT-3632	LESTER	17577	STR-7005
LESTER	6819	STR-4390	LESTER	8579	ALT-3640	LESTER	17578	STR-7006
LESTER	6820	STR-4294	LESTER	8580	ALT-3652	LESTER	18113	STR-2380
LESTER	6821	STR-4295	LESTER	8581	ALT-3652	LESTER	18241	STR-6138
LESTER	6822	STR-4290	LESTER	8582	ALT-3652	LESTER	18242	STR-0300
LESTER	6825	STR-4290	LESTER	8583	ALT-3652	LESTER	18375	STR-2391
LESTER	6826	STR-4391	LESTER	8585	ALT-3652	LESTER	18971	STR-7010
LESTER	6827	STR-4292	LESTER	8586	ALT-3652	LESTER	23876	ALT-2117B
LESTER	6828	STR-4291	LESTER	8590	ALT-3651	LESTER	23877	ALT-2117A
LESTER	6829	STR-4390	LESTER	8591	ALT-3651	LESTER	12490 [3]	ALT-1241
LESTER	6830	STR-4294	LESTER	8592	ALT-3651	LESTER	12491 [3]	ALT-1240
LESTER	6831	STR-0123	LESTER	8593	ALT-3651	LESTER	12715 [5]	ALT-1281
LESTER	6832	STR-0131	LESTER	8594	ALT-3651	LESTER	12716 [5]	ALT-1280
LESTER	6833	STR-0130	LESTER	8595	ALT-3650	LESTER	16563 [4]	STR-7072
LESTER	6834	STR-0122	LESTER	8596	ALT-3650	LESTER	17037 [11]	STR-7005
LESTER	6836	STR-4391	LESTER	8597	ALT-3650	LESTER	17095 [4]	STR-7072
LESTER	6840	STR-0140	LESTER	8598	ALT-3652	LESTER	17802 [10]	STR-7006
LESTER	6841	STR-0143	LESTER	8599	ALT-3650	LESTER	18005 [17]	STR-4303
LESTER	6842	STR-0141	LESTER	8600	ALT-3600	LESTER	18005 [8]	STR-4303
LESTER	6843	STR-0144	LESTER	8601	ALT-3600	LESTER	18021 [17]	STR-4303
LESTER	6844	STR-0142	LESTER	8602	ALT-3600	LESTER	18021 [8]	STR-4303
LESTER	6851	STR-4390	LESTER	8603	ALT-3600	LESTER	18022 [17]	STR-4302
LESTER	6852	STR-4390	LESTER	8604	ALT-3602	LESTER	18022 [8]	STR-4302
LESTER	6853	STR-4390	LESTER	8605	ALT-3602	LESTER	18176 [17]	STR-4200
LESTER	6854	STR-4293	LESTER	8606	ALT-3601	LESTER	18176 [8]	STR-4200
LESTER	6855	STR-4293	LESTER	8607	ALT-3652	LESTER	18269 [17]	STR-4303
LESTER	6856	STR-4292	LESTER	8608	ALT-3651	LESTER	18269 [8]	STR-4303
LESTER	6910	STR-4293	LESTER	8609	ALT-3651	LESTER	18360 [1]	STR-2050
LESTER	6911	STR-4292	LESTER	8612	ALT-3602	LESTER	18570 [16]	STR-4290
LESTER	6912	STR-4292	LESTER	8613	ALT-3601	LESTER	18570 [7]	STR-4290
LESTER	6913	STR-4292	LESTER	8614	ALT-3600	LESTER	18571 [16]	STR-4290
LESTER	6914	STR-4295	LESTER	8701	ALT-1241	LESTER	18571 [7]	STR-4290
LESTER	7613	ALT-1282	LESTER	8702	ALT-1241	LESTER	18970 [7]	STR-4295
LESTER	8057	ALT-0050	LESTER	8703	ALT-1241	LESTER	19520 [16]	STR-4292
LESTER	8058	ALT-0050	LESTER	8704	ALT-1241	LESTER	19520 [7]	STR-4292
LESTER	8070	ALT-1002	LESTER	8705	ALT-1240	LESTER	19535 [16]	STR-4390
LESTER	8071	ALT-1002	LESTER	8706	ALT-1240	LESTER	19535 [7]	STR-4390
LESTER	8072	ALT-1002	LESTER	8707	ALT-1240	LESTER	19577 [16]	STR-4390
LESTER	8073	ALT-1004	LESTER	8710	ALT-1241	LESTER	19577 [7]	STR-4390
LESTER	8074	ALT-1002	LESTER	8718	ALT-1241	LESTER	3130 [17]	STR-4302
LESTER	8075	ALT-1004	LESTER	8719	ALT-1240	LESTER	3130 [8]	STR-4302
LESTER	8076	ALT-1004	LESTER	8740	ALT-1280	LESTER	3300 [4]	STR-7051
LESTER	8078	ALT-1002	LESTER	8741	ALT-1280	LESTER	3339 [8]	STR-4202
LESTER	8079	ALT-1004	LESTER	8742	ALT-1281	LESTER	3706 [17]	STR-4302
LESTER	8080	ALT-3632	LESTER	8743	ALT-1281	LESTER	3706 [8]	STR-4302
LESTER	8081	ALT-3632	LESTER	8744	ALT-1282	LESTER	3713 [17]	STR-4303
LESTER	8082	ALT-3632	LESTER	8745	ALT-1282	LESTER	3713 [8]	STR-4303
LESTER	8083	ALT-3632	LESTER	12167	ALT-0108	LESTER	3745 [17]	STR-4302
LESTER	8090	ALT-3641	LESTER	12293	ALT-0106	LESTER	3745 [8]	STR-4302
LESTER	8091	ALT-3641	LESTER	12376	ALT-T150	LESTER	3745-278 [17]	STR-4302
LESTER	8092	ALT-3641	LESTER	12377	ALT-T141	LESTER	3745-278 [8]	STR-4302
LESTER	8093	ALT-3641	LESTER	12382	ALT-2300U	LESTER	3745-292 [17]	STR-4302
LESTER	8095	ALT-3640	LESTER	12383	ALT-2300U	LESTER	3745-292 [8]	STR-4302

*See page 43 for all footnotes

INTERCHANGE DATA

Manufacturer	OEM Part #	Meritor	Manufacturer	OEM Part #	Meritor	Manufacturer	OEM Part #	Meritor
LESTER	3745-308 [17]	STR-4302	LESTER	5300 [8]	STR-4202	MACK TRUCK	8MJ4172P3 [8]	STR-4202
LESTER	3745-308 [8]	STR-4302	LESTER	5311 [17]	STR-4200	MACK TRUCK	8MJ4172T [8]	STR-4200
LESTER	3745-322 [17]	STR-4303	LESTER	5311 [8]	STR-4200	MACK TRUCK	8MJ417P1	STR-4200
LESTER	3745-322 [8]	STR-4303	LESTER	5320 [17]	STR-4302	MACK TRUCK	8MJ4267M	STR-4200
LESTER	3745-38 [17]	STR-4302	LESTER	5320 [8]	STR-4302	MACK TRUCK	8MJ4298AM [7]	STR-4292
LESTER	3745-38 [8]	STR-4302	LESTER	5321 [17]	STR-4200	MACK TRUCK	8MJ498P3 [8]	STR-4200
LESTER	3745-82 [17]	STR-4302	LESTER	5321 [8]	STR-4200	MACK TRUCK	8MJ5439M [7]	STR-4292
LESTER	3745-82 [8]	STR-4302	LESTER	5322 [17]	STR-4200	MAN	51-26101-6084	ALT-T150
LESTER	3745-85 [17]	STR-4302	LESTER	5322 [8]	STR-4200	MAN	51-26201-7029	STR-2381
LESTER	3745-85 [8]	STR-4302	LESTER	5327 [17]	STR-4200	MAN	51-26201-7092	STR-2380
LESTER	3749 [17]	STR-4302	LESTER	5327 [8]	STR-4200	MAN	51-26201-7109	STR-2380
LESTER	3749 [8]	STR-4302	LESTER	5601 [17]	STR-4303	MAN	51-26201-7125	STR-2380
LESTER	3751 [17]	STR-4302	LESTER	5601 [8]	STR-4303	MAN	51-26201-7185	ALT-0110
LESTER	3751 [8]	STR-4302	LESTER	6167 [4]	STR-7054	MAN	51-26201-7192	ALT-0102
LESTER	3751-202 [17]	STR-4302	LESTER	6209 [17]	STR-4200	MAN	51-26201-7195	ALT-0102
LESTER	3751-202 [8]	STR-4302	LESTER	6209 [8]	STR-4200	MAN	51-26201-7201	ALT-0110
LESTER	3751-278 [17]	STR-4302	LESTER	6212 [17]	STR-4302	MAN	81-26101-6046	ALT-T150
LESTER	3751-278 [8]	STR-4302	LESTER	6212 [8]	STR-4302	MAN	81-26101-6064	ALT-T150
LESTER	3751-292 [17]	STR-4302	LESTER	6243 [17]	STR-4200	MAN	81-26101-6072	ALT-T150
LESTER	3751-292 [8]	STR-4302	LESTER	6343 [4]	STR-7055	MAN	81-26101-6079	ALT-T150
LESTER	3751-308 [17]	STR-4302	LESTER	6349 [8]	STR-4202	MAN	81-26101-6081	ALT-T150
LESTER	3751-308 [8]	STR-4302	LESTER	7138 [2]	ALT-1004	MAN	81-26101-6084	ALT-T150
LESTER	3751-322 [17]	STR-4302	LESTER	7602 [12]	ALT-0050	MAN	81-26101-9029	STR-2381
LESTER	3751-322 [8]	STR-4302	LESTER	7608 [12]	ALT-0050	MAN	81-26101-9046	ALT-T150
LESTER	3751-38 [17]	STR-4302	LESTER	7611 [12]	ALT-0050	MCI	7C-1-2 [17]	STR-4302
LESTER	3751-38 [8]	STR-4302	LESTER	7612 [2]	ALT-0050	MCI	7L-13-3998	ALT-T141
LESTER	3751-52 [17]	STR-4302	LESTER	7613 [12]	ALT-0060	MCI	MC2378 [16]	STR-4390
LESTER	3751-52 [8]	STR-4302	LESTER	7614 [12]	ALT-0060	MERCEDES BENZ	001-151-97-01	STR-2391
LESTER	3751-68 [17]	STR-4302	LESTER	7659 [2]	ALT-1004	MERCEDES BENZ	001-154-50-02	ALT-T145
LESTER	3751-68 [8]	STR-4302	LESTER	7662 [2]	ALT-1002	MERCEDES BENZ	002-151-53-01	STR-2380
LESTER	3764 [4]	STR-7055	LESTER	7669 [2]	ALT-1002	MERCEDES BENZ	003-151-29-01	STR-2050
LESTER	3767 [17]	STR-4200	LESTER	7672 [2]	ALT-1002	MERCEDES BENZ	003-151-41-01	STR-2380
LESTER	3767 [8]	STR-4200	LESTER	7679 [2]	ALT-1002	MERCEDES BENZ	003-151-45-01	STR-2380
LESTER	3768 [17]	STR-4200	LESTER	7685 [2]	ALT-1002	MERCEDES BENZ	003-151-46-01	STR-2391
LESTER	3768 [8]	STR-4200	LESTER	7843 [2]	ALT-1004	MERCEDES BENZ	003-151-98-01	STR-2050
LESTER	3936 [8]	STR-4202	LESTER	8024 [2]	ALT-1004	MERCEDES BENZ	004-151-35-01	STR-2050
LESTER	3938 [17]	STR-4200	LESTER	8027 [2]	ALT-1004	MERCEDES BENZ	004-151-44-01 [1]	STR-2050
LESTER	3938 [8]	STR-4200	LESTER	8087 [2]	ALT-1002	MERCEDES BENZ	004-151-56-01	STR-2050
LESTER	3939 [17]	STR-4200	LESTER	8088 [2]	ALT-1002	MERCEDES BENZ	004-151-60-01	STR-2380
LESTER	3939 [8]	STR-4200	LESTER	8348 [12]	ALT-0070	MERCEDES BENZ	004-151-63-01	STR-2050
LESTER	3948 [17]	STR-4303	LESTER	8396 [5]	ALT-1282	MERCEDES BENZ	004-151-67-01 [1]	STR-2050
LESTER	3948 [8]	STR-4303	LESTER	8576 [5]	ALT-1280	MERCEDES BENZ	005-151-13-01	STR-2050
LESTER	3948-82 [17]	STR-4303	LESTER	8658 [5]	ALT-1282	MERCEDES BENZ	005-151-29-01 [1]	STR-2050
LESTER	3948-82 [8]	STR-4303	LESTER	8672 [5]	ALT-1282	MERCEDES BENZ	005-151-66-01 [1]	STR-2050
LESTER	3962 [17]	STR-4200	LESTER	8674 [5]	ALT-1282	MERCEDES BENZ	005-154-35-02	ALT-T145
LESTER	3962 [8]	STR-4200	LESTER	8692 [2]	ALT-1004	MERCEDES BENZ	005-154-84-02	ALT-T145
LESTER	3974 [17]	STR-4200	MACK TRUCK	274210255	ALT-0050	MERCEDES BENZ	006-154-21-02	ALT-T145
LESTER	3974 [8]	STR-4200	MACK TRUCK	5034110555	ALT-0050	MERCEDES BENZ	006-154-68-02	ALT-0110
LESTER	3978 [17]	STR-4200	MACK TRUCK	5034110573	ALT-0060	MERCEDES BENZ	006-154-86-02	ALT-T145
LESTER	3978 [8]	STR-4200	MACK TRUCK	247210255A	ALT-0050	MERCEDES BENZ	007-154-27-02	ALT-0110
LESTER	3979 [17]	STR-4302	MACK TRUCK	274210255A [12]	ALT-0050	MERCEDES BENZ	007-154-92-02	ALT-0102
LESTER	3979 [8]	STR-4302	MACK TRUCK	2MJ4112P2 [12]	ALT-0050	MERCEDES BENZ	007-154-99-02	ALT-0102
LESTER	3987 [8]	STR-4202	MACK TRUCK	2MJ4112P2X [12]	ALT-0050	MERCEDES BENZ	008-154-78-02	ALT-T145
LESTER	4000 [4]	STR-7072	MACK TRUCK	2MJ4112P3 [12]	ALT-0050	MERCEDES BENZ	009-154-09-02	ALT-T145
LESTER	4389 [4]	STR-7054	MACK TRUCK	2MJ4112P4 [12]	ALT-0050	MERCEDES BENZ	009-154-99-02	ALT-0114
LESTER	4726 [17]	STR-4200	MACK TRUCK	2MJ4116P2 [12]	ALT-0050	MERCEDES BENZ	010-154-00-02	ALT-0114
LESTER	4726 [8]	STR-4200	MACK TRUCK	2MJ4116P3 [12]	ALT-0050	MERCEDES BENZ	010-154-92-02	ALT-0114
LESTER	4728 [17]	STR-4200	MACK TRUCK	2MJ4116P4 [12]	ALT-0050	MERCEDES BENZ	011-154-86-02	ALT-2110
LESTER	4728 [8]	STR-4200	MACK TRUCK	2MJ4116P5 [12]	ALT-0050	MERCEDES BENZ	011-154-87-02	ALT-2111
LESTER	4729 [8]	STR-4202	MACK TRUCK	2MJ4116P7 [12]	ALT-0050	MERCEDES BENZ	011-154-96-02	ALT-T150
LESTER	4806 [17]	STR-4200	MACK TRUCK	2MJ4116P8 [12]	ALT-0060	MERCEDES BENZ	012-154-04-02	ALT-2110
LESTER	4806 [8]	STR-4200	MACK TRUCK	2MJ4125 [12]	ALT-0060	MERCEDES BENZ	012-154-05-02	ALT-2111
LESTER	4864 [17]	STR-4200	MACK TRUCK	2MJ4125P2 [12]	ALT-0060	MERCEDES BENZ	012-154-11-02	ALT-2111
LESTER	4864 [8]	STR-4200	MACK TRUCK	2MJ516M	ALT-1241	MERCEDES BENZ	012-154-20-02	ALT-2300U
LESTER	4865 [17]	STR-4200	MACK TRUCK	2MJ516M2	ALT-1241	MERCEDES BENZ	012-154-24-02	ALT-2300U
LESTER	4865 [8]	STR-4200	MACK TRUCK	2MJ516M3	ALT-1241	MERCEDES BENZ	012-154-68-02	ALT-2110
LESTER	4936 [17]	STR-4200	MACK TRUCK	50342526J [12]	ALT-0050	MERCEDES BENZ	013-154-17-02	ALT-2300U
LESTER	4936 [8]	STR-4200	MACK TRUCK	50342526L [12]	ALT-0050	MERCEDES BENZ	013-154-28-02	ALT-2110
LESTER	4975-308 [17]	STR-4302	MACK TRUCK	5034M105032 [6]	STR-0121	MERCEDES BENZ	013-154-41-02	ALT-2111
LESTER	4975-308 [8]	STR-4302	MACK TRUCK	5034-M105302	STR-0121	MERCEDES BENZ	366-150-20-50	ALT-0110
LESTER	4976 [8]	STR-4202	MACK TRUCK	8MJ176 [8]	STR-4302	MERCEDES BENZ	LN-M105302 [6]	STR-0121
LESTER	4980 [8]	STR-4202	MACK TRUCK	8MJ4172P1 [8]	STR-4200	DAIHATSU	80472	STR-4394

INTERCHANGE DATA

Manufacturer	OEM Part #	Meritor	Manufacturer	OEM Part #	Meritor	Manufacturer	OEM Part #	Meritor
MITSUBISHI	83671	STR-4394	MITSUBISHI	PC1379 [16]	STR-4292	PRESTOLITE (LEECE-NEVILLE)	2600J [12]	ALT-0050
MITSUBISHI	M3T33481	STR-3571	MITSUBISHI	PC1379 [7]	STR-4292	PRESTOLITE (LEECE-NEVILLE)	2600JB [12]	ALT-0050
MITSUBISHI	M3T49982	STR-3571	MITSUBISHI	PC1479 [16]	STR-4292	PRESTOLITE (LEECE-NEVILLE)	2600JC [12]	ALT-0050
MITSUBISHI	M009T70279 [7]	STR-4295	MITSUBISHI	PC1479 [7]	STR-4292	PRESTOLITE (LEECE-NEVILLE)	2670J [12]	ALT-0050
MITSUBISHI	M009T70579 [16]	STR-4292	MITSUBISHI	PC1579 [16]	STR-4292	PRESTOLITE (LEECE-NEVILLE)	2670JB [12]	ALT-0050
MITSUBISHI	M009T70579 [7]	STR-4292	MITSUBISHI	PC1579 [7]	STR-4292	PRESTOLITE (LEECE-NEVILLE)	2670JC [12]	ALT-0050
MITSUBISHI	M009T70979 [16]	STR-4292	MITSUBISHI	PC1779 [16]	STR-4292	PRESTOLITE (LEECE-NEVILLE)	2670LC [12]	ALT-0050
MITSUBISHI	M009T70979 [7]	STR-4292	MITSUBISHI	PC1779 [7]	STR-4292	PRESTOLITE (LEECE-NEVILLE)	2700J [12]	ALT-0050
MITSUBISHI	M009T82479 [16]	STR-4390	MITSUBISHI	PC1879 [16]	STR-4292	PRESTOLITE (LEECE-NEVILLE)	2700JB [12]	ALT-0050
MITSUBISHI	M009T82479 [7]	STR-4390	MITSUBISHI	PC1879 [7]	STR-4292	PRESTOLITE (LEECE-NEVILLE)	2700JC [12]	ALT-0050
MITSUBISHI	M009T83671	STR-4394	MITSUBISHI	PV2479 [16]	STR-4390B	PRESTOLITE (LEECE-NEVILLE)	2700LC [12]	ALT-0050
MITSUBISHI	M2T66871	STR-6138	MITSUBISHI	VV0279 [7]	STR-4295	PRESTOLITE (LEECE-NEVILLE)	2702LC [12]	ALT-0050
MITSUBISHI	M2T67871	STR-6138	MITSUBISHI	VV0776 [16]	STR-4292	PRESTOLITE (LEECE-NEVILLE)	2800J [12]	ALT-0060
MITSUBISHI	M3T56071	STR-0300	MITSUBISHI	VV0776 [7]	STR-4292	PRESTOLITE (LEECE-NEVILLE)	2800JB [12]	ALT-0060
MITSUBISHI	M3T56072	STR-0300	MITSUBISHI	VV0879 [7]	STR-4295	PRESTOLITE (LEECE-NEVILLE)	2800JC [12]	ALT-0060
MITSUBISHI	M3T56074	STR-0300	MITSUBISHI	VV0977 [16]	STR-4292	PRESTOLITE (LEECE-NEVILLE)	2800JB [12]	ALT-0060
MITSUBISHI	M3T56082	STR-0300	MITSUBISHI	VV0977 [7]	STR-4292	PRESTOLITE (LEECE-NEVILLE)	2800LC [12]	ALT-0060
MITSUBISHI	M3T90071 [11]	STR-7005	MITSUBISHI	VV0979 [16]	STR-4292	PRESTOLITE (LEECE-NEVILLE)	2801LC [12]	ALT-0060
MITSUBISHI	M3T90072 [11]	STR-7005	MITSUBISHI	VV0979 [7]	STR-4292	PRESTOLITE (LEECE-NEVILLE)	2802J [12]	ALT-0060
MITSUBISHI	M8T50071	STR-7006	MITSUBISHI	VV1076 [16]	STR-4292	PRESTOLITE (LEECE-NEVILLE)	2802JB [12]	ALT-0060
MITSUBISHI	M8T50072	STR-7006	MITSUBISHI	VV1076 [7]	STR-4292	PRESTOLITE (LEECE-NEVILLE)	2802JC [12]	ALT-0060
MITSUBISHI	M8T50171	STR-7005	MITSUBISHI	VV1979 [16]	STR-4292	PRESTOLITE (LEECE-NEVILLE)	2802LC [12]	ALT-0060
MITSUBISHI	M8T50172	STR-7005	MITSUBISHI	VV1979 [7]	STR-4292	PRESTOLITE (LEECE-NEVILLE)	2805J [12]	ALT-0060
MITSUBISHI	M8T55073	STR-7010	MITSUBISHI	VV2079 [16]	STR-4292	PRESTOLITE (LEECE-NEVILLE)	2805JB [12]	ALT-0060
MITSUBISHI	M9T70279 [7]	STR-4295	MITSUBISHI	VV2079 [7]	STR-4292	PRESTOLITE (LEECE-NEVILLE)	2805JC [12]	ALT-0060
MITSUBISHI	M9T70579 [16]	STR-4292	NIKKO	0-23000-1581	STR-7055	PRESTOLITE (LEECE-NEVILLE)	2805LC [12]	ALT-0060
MITSUBISHI	M9T70579 [7]	STR-4292	NIKKO	0-23000-1588	STR-7055	PRESTOLITE (LEECE-NEVILLE)	2813J [5]	ALT-1282
MITSUBISHI	M9T70979 [16]	STR-4292	NIKKO	0-23000-1810	STR-7051	PRESTOLITE (LEECE-NEVILLE)	2813JC [5]	ALT-1282
MITSUBISHI	M9T70979 [7]	STR-4292	NIKKO	0-23000-1818	STR-7051	PRESTOLITE (LEECE-NEVILLE)	2813LC [5]	ALT-1282
MITSUBISHI	M9T72078 [7]	STR-4295	NIKKO	0-23000-1830	STR-7054	PRESTOLITE (LEECE-NEVILLE)	2824J [5]	ALT-1282
MITSUBISHI	M9T82378 [16]	STR-4390	NIKKO	0-23000-1870	STR-7054	PRESTOLITE (LEECE-NEVILLE)	2824JB [5]	ALT-1282
MITSUBISHI	M9T82378 [7]	STR-4390	NIKKO	0-23000-2060	STR-7072	PRESTOLITE (LEECE-NEVILLE)	2824LC [5]	ALT-1282
MITSUBISHI	M9T82479 [16]	STR-4390B	NIKKO	0-23000-2220	STR-7075	PRESTOLITE (LEECE-NEVILLE)	2825LC [5]	ALT-1282
MITSUBISHI	M9T83671	STR-4394	NIKKO	0-23000-2230	STR-7056	PRESTOLITE (LEECE-NEVILLE)	2828LC [5]	ALT-1282
MITSUBISHI	FL0379 [7]	STR-4293	NIKKO	0-23000-2234	STR-7056	PRESTOLITE (LEECE-NEVILLE)	2913J [5]	ALT-1282
MITSUBISHI	FL0579 [16]	STR-4292	NIKKO	0-23000-2380	STR-7056	PRESTOLITE (LEECE-NEVILLE)	2913JC [5]	ALT-1282
MITSUBISHI	FL0579 [7]	STR-4292	NIKKO	0-23000-2430	STR-7051	PRESTOLITE (LEECE-NEVILLE)	2913L [5]	ALT-1282
MITSUBISHI	FL0777 [16]	STR-4292	NIKKO	0-23000-2434	STR-7051	PRESTOLITE (LEECE-NEVILLE)	291LC [5]	ALT-1282
MITSUBISHI	FL0777 [7]	STR-4292	NIKKO	0-23000-2440	STR-7056	PRESTOLITE (LEECE-NEVILLE)	35258810 [4]	STR-7072
MITSUBISHI	FL0975 [16]	STR-4292	NIKKO	0-23000-2444	STR-7056	PRESTOLITE (LEECE-NEVILLE)	35258940 [4]	STR-7051
MITSUBISHI	FL0975 [7]	STR-4292	NIKKO	0-23000-2450	STR-7051	PRESTOLITE (LEECE-NEVILLE)	35259150 [10]	STR-7006
MITSUBISHI	FL1179 [7]	STR-4293	NIKKO	0-23000-2480	STR-7056	PRESTOLITE (LEECE-NEVILLE)	35259150S [10]	STR-7006
MITSUBISHI	IN0976 [16]	STR-4292	NIKKO	0-24000-3200	STR-0143	PRESTOLITE (LEECE-NEVILLE)	35261020 [10]	STR-7006
MITSUBISHI	IN0976 [7]	STR-4292	NIKKO	8-233000-3040	STR-7075	PRESTOLITE (LEECE-NEVILLE)	35261020S [10]	STR-7006
MITSUBISHI	IN1478 [16]	STR-4292	OSHKOSH TRUCK	55700CX [12]	ALT-0050	PRESTOLITE (LEECE-NEVILLE)	4830LC [12]	ALT-0070
MITSUBISHI	IN1478 [7]	STR-4292	OSHKOSH TRUCK	62235CX [12]	ALT-0060	PRESTOLITE (LEECE-NEVILLE)	4836AAH [5]	ALT-1282
MITSUBISHI	M93579 [7]	STR-4292	OSHKOSH TRUCK	62236CX [12]	ALT-0050	PRESTOLITE (LEECE-NEVILLE)	4836LGH [5]	ALT-1282
MITSUBISHI	MC2378 [16]	STR-4390	OSHKOSH TRUCK	EE34665 [12]	ALT-0050	PRESTOLITE (LEECE-NEVILLE)	4846AAH [5]	ALT-1282
MITSUBISHI	MC2378 [7]	STR-4390	OTTAWA TRUCK	90022950	STR-9050	PRESTOLITE (LEECE-NEVILLE)	7268M [17]	STR-4200
MITSUBISHI	ME017035	STR-6138	PACCAR	D61-6002-004 [7]	STR-4292	PRESTOLITE (LEECE-NEVILLE)	7268M [8]	STR-4200
MITSUBISHI	ME017085	STR-6138	PACCAR	D61-6002-008 [7]	STR-4292	PRESTOLITE (LEECE-NEVILLE)	7400M [17]	STR-4302
MITSUBISHI	ME037465	STR-0300	PETERBILT	110-573	ALT-0060	PRESTOLITE (LEECE-NEVILLE)	7400M [8]	STR-4302
MITSUBISHI	ME037636	STR-0300	PRESTOLITE (LEECE-NEVILLE)	1277640 [14]	ALT-T145	PRESTOLITE (LEECE-NEVILLE)	7400MA [17]	STR-4302
MITSUBISHI	ME067611	STR-0300	PRESTOLITE (LEECE-NEVILLE)	1277680 [14]	ALT-T141	PRESTOLITE (LEECE-NEVILLE)	7400MA [8]	STR-4302
MITSUBISHI	ME077048	STR-0300	PRESTOLITE (LEECE-NEVILLE)	1277770 [14]	ALT-T150	PRESTOLITE (LEECE-NEVILLE)	7400MC [17]	STR-4302
MITSUBISHI	ME215097	STR-7010	PRESTOLITE (LEECE-NEVILLE)	2300JB [12]	ALT-0050	PRESTOLITE (LEECE-NEVILLE)	7400MC [8]	STR-4302
MITSUBISHI	MIB970777 [7]	STR-4292	PRESTOLITE (LEECE-NEVILLE)	2331GH [5]	ALT-1282	PRESTOLITE (LEECE-NEVILLE)	93074 [17]	STR-4200
MITSUBISHI	MIB970975 [7]	STR-4292	PRESTOLITE (LEECE-NEVILLE)	2333GH [5]	ALT-1282	PRESTOLITE (LEECE-NEVILLE)	93074 [8]	STR-4200
MITSUBISHI	MIB971179 [7]	STR-4292	PRESTOLITE (LEECE-NEVILLE)	2360J [12]	ALT-0050	PRESTOLITE (LEECE-NEVILLE)	A0012300JB [12]	ALT-0050
MITSUBISHI	MITIN1378 [7]	STR-4295	PRESTOLITE (LEECE-NEVILLE)	2360JB [12]	ALT-0050	PRESTOLITE (LEECE-NEVILLE)	A0012360JB [12]	ALT-0050
MITSUBISHI	MK0077 [16]	STR-4292	PRESTOLITE (LEECE-NEVILLE)	2400J [12]	ALT-0050	PRESTOLITE (LEECE-NEVILLE)	A0012502LC [12]	ALT-0050
MITSUBISHI	MK0077 [7]	STR-4292	PRESTOLITE (LEECE-NEVILLE)	2400JB [12]	ALT-0050	PRESTOLITE (LEECE-NEVILLE)	A001250JB [12]	ALT-0050
MITSUBISHI	MK1075 [16]	STR-4292	PRESTOLITE (LEECE-NEVILLE)	2500J [12]	ALT-0050	PRESTOLITE (LEECE-NEVILLE)	A0012526JB [12]	ALT-0050
MITSUBISHI	MK1075 [7]	STR-4292	PRESTOLITE (LEECE-NEVILLE)	2500JB [12]	ALT-0050	PRESTOLITE (LEECE-NEVILLE)	A0012526JC [12]	ALT-0050
MITSUBISHI	MK1078 [16]	STR-4292	PRESTOLITE (LEECE-NEVILLE)	2500JC [12]	ALT-0050	PRESTOLITE (LEECE-NEVILLE)	A0012526LC [12]	ALT-0050
MITSUBISHI	MK1078 [7]	STR-4292	PRESTOLITE (LEECE-NEVILLE)	2500LC [12]	ALT-0050	PRESTOLITE (LEECE-NEVILLE)	A0012600JB [12]	ALT-0050
MITSUBISHI	MK2078 [16]	STR-4292	PRESTOLITE (LEECE-NEVILLE)	2502LC [12]	ALT-0050	PRESTOLITE (LEECE-NEVILLE)	A0012600LC [12]	ALT-0050
MITSUBISHI	MK2078 [7]	STR-4292	PRESTOLITE (LEECE-NEVILLE)	2510J [12]	ALT-0050	PRESTOLITE (LEECE-NEVILLE)	A0012670JB [12]	ALT-0050
MITSUBISHI	PC0779 [16]	STR-4292	PRESTOLITE (LEECE-NEVILLE)	2526J [12]	ALT-0050	PRESTOLITE (LEECE-NEVILLE)	A0012670JC [12]	ALT-0050
MITSUBISHI	PC0779 [7]	STR-4292	PRESTOLITE (LEECE-NEVILLE)	2526JB [12]	ALT-0050	PRESTOLITE (LEECE-NEVILLE)	A0012670LC [12]	ALT-0050
MITSUBISHI	PC0979 [16]	STR-4292	PRESTOLITE (LEECE-NEVILLE)	2526JC [12]	ALT-0050	PRESTOLITE (LEECE-NEVILLE)	A0012700JB [12]	ALT-0050
MITSUBISHI	PC0979 [7]	STR-4292	PRESTOLITE (LEECE-NEVILLE)	2526LC [12]	ALT-0050	PRESTOLITE (LEECE-NEVILLE)	A0012700JC [12]	ALT-0050

*See page 43 for all footnotes

INTERCHANGE DATA

Manufacturer	OEM Part #	Meritor	Manufacturer	OEM Part #	Meritor	Manufacturer	OEM Part #	Meritor
PRESTOLITE (LEECE-NEVILLE)	A0012700LC [12]	ALT-0050	PRESTOLITE (MOTOROLA)	8LHA2070V	ALT-0050	PRESTOLITE	46-2079 [17]	STR-4200
PRESTOLITE (LEECE-NEVILLE)	A0012800JB [12]	ALT-0060	PRESTOLITE (MOTOROLA)	8LHA2070VA	ALT-0050	PRESTOLITE	46-2079 [8]	STR-4200
PRESTOLITE (LEECE-NEVILLE)	A0012800JC [12]	ALT-0060	PRESTOLITE (MOTOROLA)	8LHA2070VB	ALT-0050	PRESTOLITE	46-2125 [17]	STR-4200
PRESTOLITE (LEECE-NEVILLE)	A0012800LC [12]	ALT-0060	PRESTOLITE (MOTOROLA)	8LHA2077VA	ALT-0050	PRESTOLITE	46-2125 [8]	STR-4200
PRESTOLITE (LEECE-NEVILLE)	A0012802J [12]	ALT-0060	PRESTOLITE (MOTOROLA)	8LHA2275V	ALT-0070	PRESTOLITE	46-2135 [17]	STR-4200
PRESTOLITE (LEECE-NEVILLE)	A0012802JB [12]	ALT-0060	PRESTOLITE (MOTOROLA)	8LHP2170V	ALT-0051	PRESTOLITE	46-2135 [8]	STR-4200
PRESTOLITE (LEECE-NEVILLE)	A0012802JC [12]	ALT-0060	PRESTOLITE (MOTOROLA)	8LHP2170VE	ALT-0051	PRESTOLITE	46-2136 [17]	STR-4200
PRESTOLITE (LEECE-NEVILLE)	A0012802LC [12]	ALT-0060	PRESTOLITE (MOTOROLA)	8LHP2177V	ALT-0051	PRESTOLITE	46-2136 [8]	STR-4200
PRESTOLITE (LEECE-NEVILLE)	A0012805JB [12]	ALT-0060	PRESTOLITE (MOTOROLA)	8LHP2253V	ALT-0051	PRESTOLITE	46-2151 [17]	STR-4303
PRESTOLITE (LEECE-NEVILLE)	A0012805JC [12]	ALT-0060	PRESTOLITE (MOTOROLA)	8LHP2276V	ALT-0071	PRESTOLITE	46-2151 [8]	STR-4303
PRESTOLITE (LEECE-NEVILLE)	A0012805LC [12]	ALT-0060	PRESTOLITE (MOTOROLA)	110-255	ALT-0050	PRESTOLITE	46-2153 [17]	STR-4200
PRESTOLITE (LEECE-NEVILLE)	A0012813JC [5]	ALT-1282	PRESTOLITE (MOTOROLA)	110-444	ALT-1004	PRESTOLITE	46-2153 [8]	STR-4200
PRESTOLITE (LEECE-NEVILLE)	A0012824JB [5]	ALT-1282	PRESTOLITE (MOTOROLA)	110-450	ALT-0060	PRESTOLITE	46-2171 [17]	STR-4302
PRESTOLITE (LEECE-NEVILLE)	A0012824LC [5]	ALT-1282	PRESTOLITE (MOTOROLA)	110-555	ALT-0050	PRESTOLITE	46-2171 [8]	STR-4302
PRESTOLITE (LEECE-NEVILLE)	A0012825LC [5]	ALT-1282	PRESTOLITE (MOTOROLA)	110-555JHO	ALT-0060	PRESTOLITE	46-2172 [17]	STR-4200
PRESTOLITE (LEECE-NEVILLE)	A0012828LC [5]	ALT-1282	PRESTOLITE (MOTOROLA)	110-555PHO	ALT-0061	PRESTOLITE	46-2172 [8]	STR-4200
PRESTOLITE (LEECE-NEVILLE)	A0012913JC [5]	ALT-1282	PRESTOLITE (MOTOROLA)	110-566P	ALT-0051	PRESTOLITE	46-2178 [17]	STR-4200
PRESTOLITE (LEECE-NEVILLE)	A0012913LC [5]	ALT-1282	PRESTOLITE (MOTOROLA)	110-573	ALT-0060	PRESTOLITE	46-2178 [8]	STR-4200
PRESTOLITE (LEECE-NEVILLE)	A0014830LC [12]	ALT-0070	PRESTOLITE (MOTOROLA)	110-579	ALT-0050	PRESTOLITE	46-2191 [17]	STR-4303
PRESTOLITE (LEECE-NEVILLE)	A0014836AAH [5]	ALT-1282	PRESTOLITE (MOTOROLA)	110-775	ALT-0070	PRESTOLITE	46-2191 [8]	STR-4303
PRESTOLITE (LEECE-NEVILLE)	A0014836LGH [5]	ALT-1282	PRESTOLITE (MOTOROLA)	110-775P	ALT-0071	PRESTOLITE	46-2231 [8]	STR-4202
PRESTOLITE (LEECE-NEVILLE)	A0014846AAH [5]	ALT-1282	PRESTOLITE (MOTOROLA)	110-777	ALT-0050	PRESTOLITE	46-2245 [8]	STR-4202
PRESTOLITE (LEECE-NEVILLE)	BLD2301	ALT-0050	PRESTOLITE (MOTOROLA)	110-777P	ALT-0051	PRESTOLITE	46-2253 [17]	STR-4200
PRESTOLITE (LEECE-NEVILLE)	BLD2305	ALT-0050	PRESTOLITE (MOTOROLA)	110-800	ALT-0050	PRESTOLITE	46-2253 [8]	STR-4200
PRESTOLITE (LEECE-NEVILLE)	BLD2307	ALT-0060	PRESTOLITE (MOTOROLA)	110-803	ALT-0060	PRESTOLITE	46-2256 [17]	STR-4302
PRESTOLITE (LEECE-NEVILLE)	BLD2331GH [5]	ALT-1282	PRESTOLITE (MOTOROLA)	LBA2115	ALT-0060	PRESTOLITE	46-2256 [8]	STR-4302
PRESTOLITE (LEECE-NEVILLE)	BLD2333GH [5]	ALT-1282	PRESTOLITE	MES6101K [17]	STR-4303	PRESTOLITE	46-2296 [17]	STR-4200
PRESTOLITE (LEECE-NEVILLE)	LBA2106	ALT-0050	PRESTOLITE	MES6101K [8]	STR-4303	PRESTOLITE	46-2296 [8]	STR-4200
PRESTOLITE (LEECE-NEVILLE)	LNS4000 [17]	STR-4200	PRESTOLITE	MES6301K [17]	STR-4303	PRESTOLITE	46-2362 [17]	STR-4200
PRESTOLITE (LEECE-NEVILLE)	LNS4000 [8]	STR-4200	PRESTOLITE	MES6301K [8]	STR-4303	PRESTOLITE	46-2362 [8]	STR-4200
PRESTOLITE (LEECE-NEVILLE)	LNS4200	STR-4200	PRESTOLITE	MES6404K [17]	STR-4303	PRESTOLITE	46-895 [17]	STR-4303
PRESTOLITE (LEECE-NEVILLE)	M106302 [6]	STR-0121	PRESTOLITE	MES6404K [8]	STR-4303	PRESTOLITE	46-895 [8]	STR-4303
PRESTOLITE (LEECE-NEVILLE)	M105703 [15]	STR-0130	PRESTOLITE	MES6404L [17]	STR-4303	PREVOST	51-0751 [16]	STR-4390
PRESTOLITE (LEECE-NEVILLE)	M105703 [6]	STR-0130	PRESTOLITE	MES6404L [8]	STR-4303	PREVOST	51-0751 [7]	STR-4390
PRESTOLITE (LEECE-NEVILLE)	M105R2002SE [6]	STR-0121	PRESTOLITE	MES6405 [17]	STR-4302	PREVOST	56-2752	ALT-T141
PRESTOLITE (LEECE-NEVILLE)	M105R3131SE	STR-4394	PRESTOLITE	MES6405 [8]	STR-4302	RENAULT	20-409-228	ALT-2117A
PRESTOLITE (LEECE-NEVILLE)	M105R3503SE [15]	STR-0130	PRESTOLITE	MES6405D [17]	STR-4302	RENAULT	20-849-349	ALT-2117A
PRESTOLITE (LEECE-NEVILLE)	M105R3503SE [6]	STR-0130	PRESTOLITE	MES6405D [8]	STR-4302	RENAULT	50-00-811-448 [17]	STR-4302
PRESTOLITE (LEECE-NEVILLE)	M125601 [16]	STR-4292	PRESTOLITE	MES6405DA [17]	STR-4302	RENAULT	50-00-811-448 [8]	STR-4302
PRESTOLITE (LEECE-NEVILLE)	M125601 [7]	STR-4292	PRESTOLITE	MES6405DA [8]	STR-4302	RENAULT	50-00-822-887	STR-2380
PRESTOLITE (LEECE-NEVILLE)	MDA2932 [2]	ALT-1004	PRESTOLITE	MES6405J [17]	STR-4302	RENAULT	50-01-000-061	STR-2380
PRESTOLITE (LEECE-NEVILLE)	MS1-401A [16]	STR-4390	PRESTOLITE	MES6405J [8]	STR-4302	RENAULT	50-10-050-904	STR-2394
PRESTOLITE (LEECE-NEVILLE)	MS1-401A [7]	STR-4390	PRESTOLITE	MES6406L [17]	STR-4303	RENAULT	50-10-347-544	ALT-T141
PRESTOLITE (LEECE-NEVILLE)	MS2-500 [16]	STR-4292	PRESTOLITE	MES6406L [8]	STR-4303	RENAULT	50-10-390-082	ALT-T141
PRESTOLITE (LEECE-NEVILLE)	MS2-500 [7]	STR-4292	PRESTOLITE	MFJ6202J [17]	STR-4200	RENAULT	50-10-589-525	ALT-2117A
PRESTOLITE (LEECE-NEVILLE)	MS2-501 [16]	STR-4292	PRESTOLITE	MFJ6202J [8]	STR-4200	RENAULT	50-10-589-551	ALT-2117B
PRESTOLITE (LEECE-NEVILLE)	MS2-501 [7]	STR-4292	PRESTOLITE	MFJ6202K [17]	STR-4200	RENAULT	50-10-589-555	ALT-2117A
PRESTOLITE (LEECE-NEVILLE)	MS2-502 [16]	STR-4292	PRESTOLITE	MFJ6202K [8]	STR-4200	RENAULT	74-20-409-228	ALT-2117A
PRESTOLITE (LEECE-NEVILLE)	MS2-502 [7]	STR-4292	PRESTOLITE	MFJ6301A [17]	STR-4200	RENAULT	74-20-466-317	ALT-2117B
PRESTOLITE (LEECE-NEVILLE)	MS2-503 [16]	STR-4292	PRESTOLITE	MFJ6301A [8]	STR-4200	RENAULT	74-20-853-850	ALT-2117A
PRESTOLITE (LEECE-NEVILLE)	MS2-503 [7]	STR-4292	PRESTOLITE	MFJ6301D [17]	STR-4200	RENAULT	74-20-862-899	ALT-2117B
PRESTOLITE (LEECE-NEVILLE)	MS2-504 [16]	STR-4292	PRESTOLITE	MFJ6301D [8]	STR-4200	SAWAFUJI	0350-402-0111 [9]	STR-6170
PRESTOLITE (LEECE-NEVILLE)	MS2-504 [7]	STR-4292	PRESTOLITE	MFJ6301J [17]	STR-4200	SAWAFUJI	0350-402-0112 [9]	STR-6170
PRESTOLITE (LEECE-NEVILLE)	MS2-507 [16]	STR-4292	PRESTOLITE	MFJ6301J [8]	STR-4200	SAWAFUJI	0350-402-0113 [9]	STR-6170
PRESTOLITE (LEECE-NEVILLE)	MS2-507 [7]	STR-4292	PRESTOLITE	MFJ6301K [17]	STR-4200	SAWAFUJI	0350-402-0114 [9]	STR-6170
PRESTOLITE (LEECE-NEVILLE)	MS2-509 [16]	STR-4292	PRESTOLITE	MFJ6301K [8]	STR-4200	SAWAFUJI	0350-402-0115 [9]	STR-6170
PRESTOLITE (LEECE-NEVILLE)	MS2-509 [7]	STR-4292	PRESTOLITE	MFJ6303B [17]	STR-4200	SAWAFUJI	0350-402-0116 [9]	STR-6170
PRESTOLITE (LEECE-NEVILLE)	MS2-510 [16]	STR-4292	PRESTOLITE	MFJ6303B [8]	STR-4200	SAWAFUJI	0350-402-0210 [9]	STR-6170
PRESTOLITE (LEECE-NEVILLE)	MS2-510 [7]	STR-4292	PRESTOLITE	MFJ6303D [17]	STR-4200	SAWAFUJI	0350-402-0211 [9]	STR-6170
PRESTOLITE (LEECE-NEVILLE)	MS2-511 [16]	STR-4292	PRESTOLITE	MFJ6303D [8]	STR-4200	SAWAFUJI	0350-702-0020 [9]	STR-9109
PRESTOLITE (LEECE-NEVILLE)	MS2-511 [7]	STR-4292	PRESTOLITE	MFJ6303J [17]	STR-4200	SAWAFUJI	0350-702-0021 [9]	STR-9109
PRESTOLITE (LEECE-NEVILLE)	MS2-514 [16]	STR-4292	PRESTOLITE	MFJ6303J [8]	STR-4200	SAWAFUJI	0350-702-0022 [9]	STR-9109
PRESTOLITE (LEECE-NEVILLE)	MS2-514 [7]	STR-4292	PRESTOLITE	MFJ6306C [17]	STR-4200	SAWAFUJI	0350-702-0023 [9]	STR-9109
PRESTOLITE (LEECE-NEVILLE)	RJ2500 [12]	ALT-0050	PRESTOLITE	MFJ6306C [8]	STR-4200	SAWAFUJI	0350-702-0024 [9]	STR-9109
PRESTOLITE (LEECE-NEVILLE)	RJ2526 [12]	ALT-0050	PRESTOLITE	MFJ6306D [17]	STR-4200	SAWAFUJI	0350-702-0025 [9]	STR-9109
PRESTOLITE (MOTOROLA)	8LHA2023R	ALT-0050	PRESTOLITE	MFJ6306D [8]	STR-4200	SAWAFUJI	0350-702-0180 [9]	STR-9109
PRESTOLITE (MOTOROLA)	8LHA2023V	ALT-0050	PRESTOLITE	MFJ6401J [8]	STR-4202	SAWAFUJI	0350-702-0220 [9]	STR-9109
PRESTOLITE (MOTOROLA)	8LHA2023VA	ALT-0050	PRESTOLITE	MFJ6401K [8]	STR-4202	SAWAFUJI	0350-702-0226 [9]	STR-9109
PRESTOLITE (MOTOROLA)	8LHA2054UA	ALT-0050	PRESTOLITE	MFJ6601D [17]	STR-4200	SAWAFUJI	0350-702-0290 [9]	STR-9109
PRESTOLITE (MOTOROLA)	8LHA2057V	ALT-0060	PRESTOLITE	MFJ6601D [8]	STR-4200	SAWAFUJI	0350-702-0294 [9]	STR-9109
PRESTOLITE (MOTOROLA)	8LHA2057VA	ALT-0060	PRESTOLITE	46-2069 [17]	STR-4303	SAWAFUJI	0350-702-0330 [9]	STR-9109
PRESTOLITE (MOTOROLA)	8LHA2070R	ALT-0050	PRESTOLITE	46-2069 [8]	STR-4303	SAWAFUJI	0350-702-0339 [9]	STR-9109

INTERCHANGE DATA

Manufacturer	OEM Part #	Meritor	Manufacturer	OEM Part #	Meritor	Manufacturer	OEM Part #	Meritor
SCANIA	257592	ALT-0108	VOLVO/DAF	240340	STR-2381	VOLVO/DAF	LN110-800	ALT-0050
SCANIA	357736	ALT-0108	VOLVO/DAF	303180	ALT-T150	VOLVO/DAF	LN-M105302	STR-0121
SCANIA	371972	ALT-0108	VOLVO/DAF	655613	ALT-T145	WESTERN STAR	02-7014930 [12]	ALT-0050
SCANIA	410676	ALT-0108	VOLVO/DAF	854300	ALT-0110	WESTERN STAR	02-7014931 [12]	ALT-0050
SCANIA	472302	ALT-T141	VOLVO/DAF	894300	ALT-0110	WESTERN STAR	80201-0018 [12]	ALT-0050
SCANIA	571519	ALT-T141	VOLVO/DAF	1089861	ALT-0106	WESTERN STAR	80201-0031 [12]	ALT-0060
SCANIA	1117252	ALT-0108	VOLVO/DAF	1607362	ALT-0106	WESTERN STAR	80201-3414 [12]	ALT-0050
SCANIA	1336136	ALT-0104	VOLVO/DAF	3803639	ALT-2117A	WESTERN STAR	80201-3415 [12]	ALT-0050
SCANIA	1409378	ALT-0104	VOLVO/DAF	3971126	STR-4202	WESTERN STAR	82001-3436	STR-4209
STEYR	519-51-00-10010	ALT-T145	VOLVO/DAF	5001680	STR-2381	WHITE	02-7017473 [8]	STR-4200
SUZUKI	31100-73010	STR-3571	VOLVO/DAF	6679261	ALT-0106	WHITE	20-7000400 [8]	STR-4202
SUZUKI	31100-73030	STR-3571	VOLVO/DAF	6799261	ALT-0106	WHITE	30-3066940 [8]	STR-4202
SUZUKI	31100-73071	STR-3571	VOLVO/DAF	7240340	STR-2381	WHITE	30-3212645 [8]	STR-4202
SUZUKI	31100-73090	STR-3571	VOLVO/DAF	8156817	ALT-0113	WHITE	30-3480429-1	STR-7051
THERMO KING	10-45-1688	STR-6009	VOLVO/DAF	11170134	ALT-2117A	WHITE	40-2505511 [12]	ALT-0050
THERMO KING	41-044000	STR-6006	VOLVO/DAF	11170321	ALT-2117A	WHITE	40-2505512 [12]	ALT-0060
THERMO KING	44-2918	STR-6001	VOLVO/DAF	20402404	ALT-0114	WHITE	40-2505513 [12]	ALT-0060
THERMO KING	45-1229	STR-6001	VOLVO/DAF	20409228	ALT-2117A	WHITE	82001-0089 [8]	STR-4200
THERMO KING	45-1263	STR-6006	VOLVO/DAF	20409240	ALT-2117A	WHITE	V1092959 [2]	ALT-1004
THERMO KING	45-1285	STR-6001	VOLVO/DAF	20409420	ALT-2117A	WHITE	V1092960 [2]	ALT-1004
THERMO KING	45-1671	STR-6006	VOLVO/DAF	20466315	ALT-2117A	WHITE	V1092961 [2]	ALT-1004
THERMO KING	45-1688	STR-6009	VOLVO/DAF	20466317	ALT-2117B	WHITE	V1092962 [2]	ALT-1004
THERMO KING	45-1993	STR-6006	VOLVO/DAF	20849349	ALT-2117A	WHITE	V1113248	STR-4250
THERMO KING	845-1263	STR-6006	VOLVO/DAF	20849350	ALT-2117A	WHITE	V1114240 [8]	STR-4202
THERMO KING	845-1285	STR-6001	VOLVO/DAF	20849351	ALT-2117A	WHITE	V1114241 [8]	STR-4200
THERMO KING	845-1285	STR-6001	VOLVO/DAF	20849352	ALT-2117B	WHITE	V1114242 [8]	STR-4202
THOMAS BUILT BUSES	61230359	STR-9050	VOLVO/DAF	85000626	ALT-2117A	WHITE	V1114243 [8]	STR-4302
THOMAS BUILT BUSES	61230712	STR-9051	VOLVO/DAF	20430285 [7]	STR-4295	WHITE	V1114247	STR-4202
TOYOTA	28100-12012	STR-3571	VOLVO/DAF	20520903 [7]	STR-4295	WHITE	V1114248	STR-4202
TOYOTA	28100-12030	STR-3571	VOLVO/DAF	20851006 [7]	STR-4292	WHITE	V1114249	STR-4200
TOYOTA	28100-12040	STR-3571	VOLVO/DAF	21001825 [7]	STR-4295	WHITE	V1114250	STR-4207
TOYOTA	28100-22010	STR-3571	VOLVO/DAF	3947594 [12]	ALT-0060	WHITE	V1114251	STR-4302
TOYOTA	28100-22011	STR-3571	VOLVO/DAF	3948717 [12]	ALT-0050	WHITE	V1114252	STR-4201
TOYOTA	28100-22012	STR-3571	VOLVO/DAF	3948719 [12]	ALT-0050	WHITE	V1114261 [2]	ALT-1004
TOYOTA	28100-22020	STR-3571	VOLVO/DAF	3948720 [12]	ALT-0060	WHITE	V1114262 [2]	ALT-1004
TOYOTA	28100-22021	STR-3571	VOLVO/DAF	3948722 [12]	ALT-0050	WHITE	V1114938	STR-4250
TOYOTA	28100-22022	STR-3571	VOLVO/DAF	3970894 [12]	ALT-0070	WHITE	V1115303	STR-4302
TOYOTA	28100-24060	STR-3571	VOLVO/DAF	3978719 [12]	ALT-0050	YALE	2200073-46	STR-5001
VOLVO	303180	ALT-T150	VOLVO/DAF	3978720 [12]	ALT-0060	YANMAR	126486-77010	STR-6009
VOLVO	1244090	ALT-T141	VOLVO/DAF	3978721 [12]	ALT-0060	YANMAR	126486-77011	STR-6009
VOLVO	3032961	ALT-T141	VOLVO/DAF	3978722 [12]	ALT-0050	YANMAR	129486-77011	STR-6009
VOLVO	9159360	ALT-T141	VOLVO/DAF	85103338 [7]	STR-4295			
VOLVO	9520621	ALT-T141	VOLVO/DAF	LN110-573	ALT-0060			
VOLVO/DAF	91295	ALT-0102						

Interchange Data Key

[1] - Bosch PLGR Replacement
 [2] - Delco 22SI Replacement
 [3] - Delco 24SI Replacement
 [4] - Delco 28MT Replacement
 [5] - Delco 28SI Replacement
 [6] - Delco 38MT Replacement

[7] - Delco 39MT Replacement
 [8] - Delco 42MT Replacement
 [9] - Denso G.R. Replacement
 [10] - Mitsubishi PLGR Replacement
 [11] - Mitsubishi/Ford Late Version
 [12] - Prestolite (Motorola) Replacement

[13] - Supplied w/relay switch
 [14] - Bosch Replacement
 [15] - Delco 38MT Replacement
 [16] - Delco 39MT Replacement
 [17] - Delco 42MT Replacement

TECH TIPS

HEAVY-DUTY ELECTRICAL SYSTEMS BASICS

Today's basic heavy-duty electrical system consists of batteries, a starting motor, an alternator, and the control circuit. The control circuit includes a magnetic switch, ignition switch, push button switch, and all the required wiring.

The batteries provide the high electrical current needed by the starting motor. The magnetic switch controls the battery current into the starter solenoid. The ignition and push button switch activate the magnetic switch, which in turn activates the starting motor. If all functions work properly, the engine should turn over. Mechanical energy from the running engine provides the power needed to operate the alternator. The alternator creates electrical energy that recharges the batteries and provides the current for the vehicle's electrical accessories and loads. The wiring should be of adequate size to carry the amount of current needed in each circuit.

When these components are properly matched, they provide a balanced electrical system that will perform well through out its life expectancy.

SYSTEM COMPONENT FUNCTIONS

Battery

A battery is a storage unit that can store and produce electrical energy. With use, they gradually deteriorate and become less capable of performing their important task.

There are three basic types of batteries used in heavy duty electrical systems:

Filler Cap

These are lead- acid batteries with a high degree of a base element called antimony in the grid alloy. Because of this base element, they require frequent servicing, particularly the need for adding water.

Semi-Maintenance Free

These are conventional batteries with reduced amounts of antimony in the grid alloy. Consequently, servicing is reduced but water still must be added periodically.

Maintenance Free

These batteries use a lead- calcium grid alloy without antimony. They never need water, nor are provisions provided for adding water.

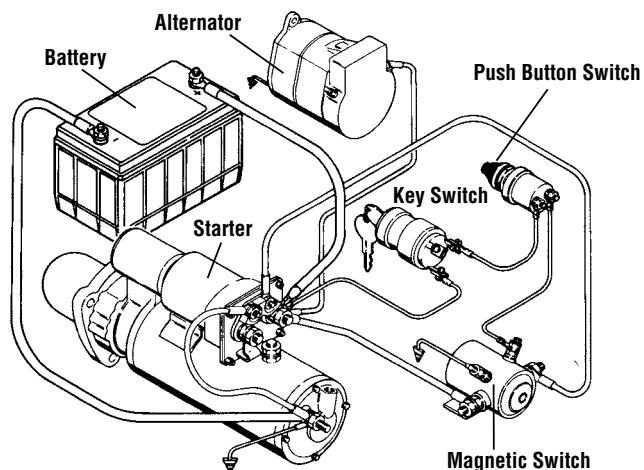

Figure 1



Figure 2

TECH TIPS

Starter

All starters, from the smallest to the largest are virtually the same. They are simply electrical motors that convert electrical energy into mechanical energy to crank the engine.

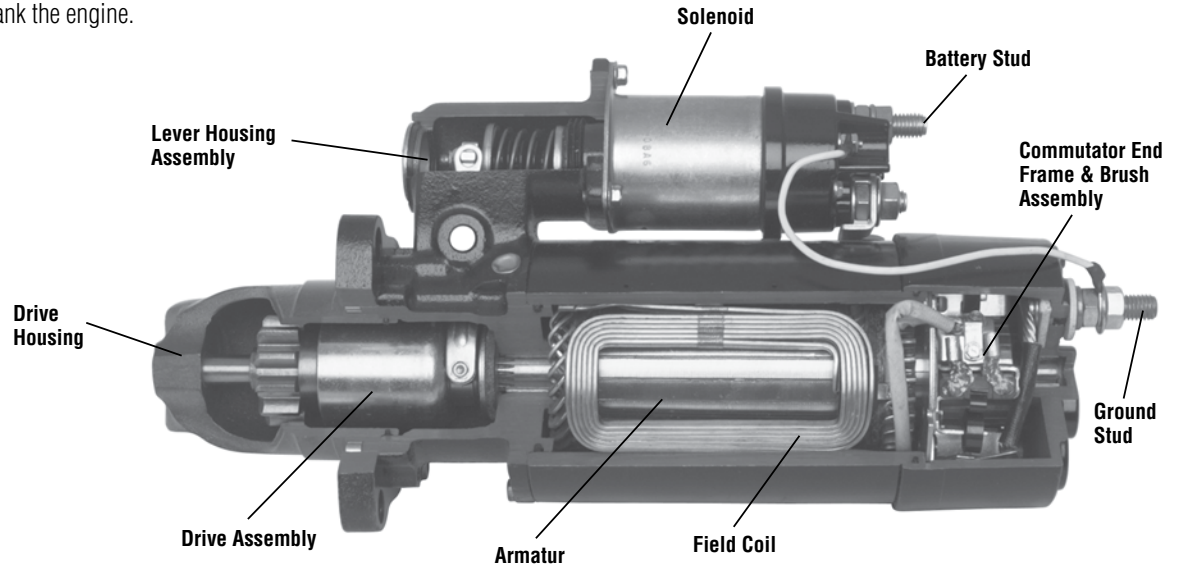

Figure 3

Alternator

An alternator is a generator that produces alternating current from mechanical energy. The use of rectifiers or diodes converts the alternating current to direct current. The direct current is used to maintain a charge in the battery and handle the electrical loads of the vehicle.

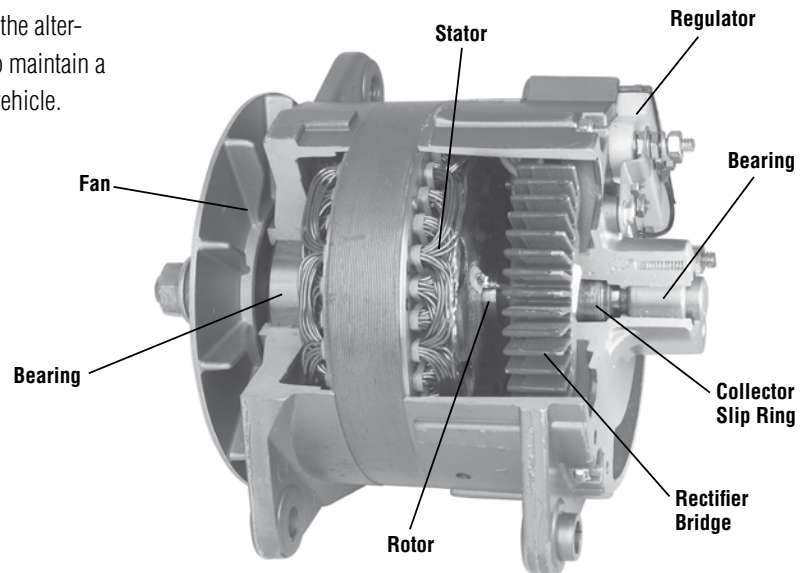

Figure 4

WIRING CIRCUITS**Cranking Circuit**

The cranking circuit consists of large cables that carry the high starter current from the battery to the solenoid. Excessive voltage loss in the circuit causes slow cranking speeds, especially in cold weather. Slow cranking can lead to starter burn up if cranked over 30 seconds. Batteries that become deeply discharged can cause the same problem.

TECH TIPS

WIRING CIRCUITS (cont'd.)

Solenoid Control Circuit

The solenoid circuit consists of the wiring from the batteries through a push button or magnetic switch to the battery “SW” (switch) terminal of the starter solenoid and back to the battery. Excessive voltage loss in this current can cause the solenoid to shift in and out (chattering) which will result in the vehicle not starting. This condition can result in a burned contact disc or terminals of the starter solenoid. When a magnetic switch is used, excessive voltage loss will also cause this switch to open and close continuously. Batteries that become deeply discharged or worn out will cause the same condition.

Charging Circuit

The charging circuit consists of the wiring between the alternator and battery. Excessive voltage loss in the circuit will prevent the batteries from being properly charged. Complete failure of the charging circuit can cause alternator damage and/or failure.

Battery Cable Size and Connections

The connections and cable size have a significant effect on the electrical system. The jumper lines between batteries should be at least #00 gauge cable. The length of the circuit has a bearing on the amount of voltage loss which occurs in each cable. Be sure that all the circuits can handle the required load (**Refer to Table 1**). The total length of a circuit is the sum of both sides of the circuit.

Corrosion and loose connections, the two largest failure causes, can be minimized by taking precautions when installing cable ends. Many times these two go hand in hand. Corrosion will cause the connections to loosen. Corrosion travels through cables causing voltage losses. To prevent corrosion trouble, seal all exposed areas. When using crimp style ends that are open ended, seal by soldering them closed. Wire that is exposed to the elements should be sealed by using shrinkable tubing.



Figure 5

Energizing Alternators

Sometimes a new alternator will not charge because the magnetic field has been lost through long shelf life or jarring during shipping and handling. The magnetic field can be energized by momentarily connecting a jumper lead from the battery positive terminal (+) on the alternator to the relay (R) or indicator (I) terminal. This procedure will restore the normal residual magnetism.

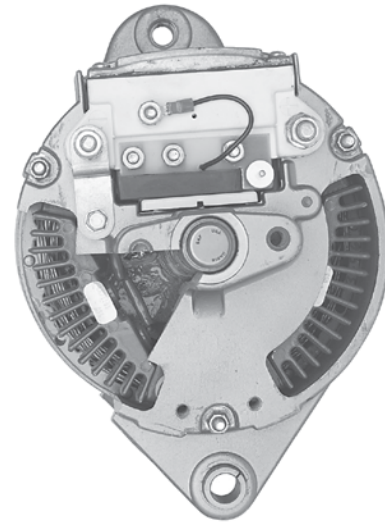

Figure 6

TOTAL CIRCUIT LENGTH GAUGE	CABLE GAUGE
Up to 144	#00
144" to 180"	#000
180" to 230"	#0000

Table 1

BASIC ELECTRICITY**Current = Electron Flow**

Current is the flow or movement of electrons. You can compare this to the flow of water. Without pressure (voltage), the current will not flow. Ampere (amps) is the unit of measure for electrical current.

Voltage = Electrical Pressure

Voltage provides the electrical pressure or force that causes current to flow. Voltage is the difference in electrical pressure between two points in a circuit.

Formulas and Definitions

All the electrical characteristics are interrelated. The basic formulas are:

$$I = E / R \quad \text{Amperes} = \text{Volts} / \text{Ohms}$$

$$E = R I \quad \text{Volts} = \text{Ohms} \times \text{Amperes}$$

$$R = E / I \quad \text{Ohms} = \text{Volts} / \text{Amperes}$$

Amps (Amperage) – measure of current flow in a circuit

Ohms (Resistance) – measure of resistance in a circuit

Volts (Electromotive force) – measure of the force that drives current flow in a circuit

Resistance

Resistance is a restriction of current flow. If resistance increases, current flow decreases. This can be detected by voltage loss in a circuit. Ohm is the unit of measure for resistance.

Magnetic Field

When forcing current through a conductor, a magnetic field is produced. Magnetic fields and direction of current flow are factors to consider when using ammeters, especially when using an induction pick up ammeter.

TECH TIPS

QUICK REFERENCE TROUBLE SHOOTING GUIDE

Symptom	Cause
Starter drags, slow or sluggish cranking	Discharged battery Loose or dirty connections Corroded or damaged cables
Solenoid chatters, won't engage the starter drive	Discharged battery Loose or dirty connections Problems in the solenoid or magnetic switch circuit
Starter will not operate at all	Starter relay problem Burned out solenoid Faulty ignition switch Open wire in cranking circuit Completely dead battery
Starter motors but will not engage the engine flywheel	Damaged or worn ring gear Wrong starter drive Incorrect mounting hole size
Starter will not disengage when key is released	Damaged or worn ring gear Starter loose on mounting hardware Starter relay or solenoid problem Faulty ignition switch
Batteries won't hold a charge	Loose or dirty connections Corroded or damaged cables Bad cell or cells in battery(s) Bad ground Loose or worn out belts or pulley
Alternator will not charge	Alternator rotor has lost residual magnetism Pulley is worn Loose or worn belts Bad ground Corroded or dirty connections
Alternator doesn't charge at low RPM	Wrong pulley diameter which causes alternator to spin too slowly at low engine RPM
Alternator is overcharging	Discharged battery or batteries Bad cell(s) in battery Regulator has failed
High alternator noise level	Worn out bearing in alternator Frayed or worn belt Loose fan or pulley Alternator mounting loose

ELECTRICAL GLOSSARY

THE LANGUAGE OF CHARGING AND STARTING SYSTEMS

ALTERNATOR – A device which converts mechanical energy to electrical energy. It maintains the battery in a fully charged state.

AMPERE (AMP) – The unit measure of electrical current flow. This movement can be compared to the flow of water through a pipe.

ARMATURE – Any part moved by magnetic attraction or repulsion. An example is the armature in a starter.

BATTERY – A device for storing energy and converting chemical energy into electrical energy.

BRUSH – A block of conducting substance, usually made of carbon, which picks up or delivers electric current from, or to, the commutator or slipper ring.

BRUSH HOLDER – Holds the brushes on an alternator or starter in position on the commutator or slipper rings.

CHARGE RATE – The amperage flowing from the alternator to the battery.

CIRCUIT – The path over which a current of electricity flows.

COLD CRANKING AMPS – The number of amperes a battery at zero degrees Fahrenheit can deliver for 30 seconds and maintain a voltage of 1.2 volts per cell or higher.

COMMUTATOR – A cylindrical device mounted on one end of an armature shaft. It is composed of copper segments insulated from each other. The ends of the armature windings are soldered to pairs of segments.

DRIVE END – The end of a starter that contains the pinion gear or “Bendix”, or the end of an alternator which is driven by a belt or a gear.

ELECTROLYTE – A solution of sulfuric acid and water used in batteries.

FIELD COILS – A coil of insulated wire which forms the windings of a starter.

FIELD HOUSING – The center section of a cranking motor (starter) that holds the field coils.

GROUND – The part of an electrical circuit used to return current from the participating unit to its source.

HYDROMETER – The instrument which measures specific gravity. In a battery it measures the weight of the electrolyte in relation to the weight of pure water.

INDUCTION – The current induced in a conductor when the conductor cuts across a magnetic field.

MAGNETIC FIELD – The gap or space around a magnet in which the magnetic lines of force travel.

OHM – The unit of electrical measurement of resistance to the flow of current in a circuit.

OPEN CIRCUIT – A circuit which is broken so that electric current cannot flow.

OVER-CRANK PROTECTION – A temperature limiting switch built into a starter. It prevents internal damage due to extended operation caused by extreme low temperatures or batteries in a low state of charge.

PARALLEL CIRCUIT – An electrical circuit in which the electrical units and conductors are connected so that the current flows over several independent paths.

PINION – The gear portion of the starter drive mechanism which engages the flywheel ring gear when rotated by the starting motor armature.

RECTIFIER – Any device, such as the diode in an alternator, which changes alternating current to direct current.

RESISTANCE – The opposition offered to the passage of electrical current through a body or substance. The ohm is the unit of resistance.

REGULATOR – A device for sensing a battery's supply of electrical energy. The regulator limits the alternators output voltage and keeps the current output of the alternator in step with the speed of the vehicle and the demand of the various accessories and the battery.

ROTOR – The rotating member of an alternator that provides the magnetic field needed to produce an electrical current.

SERIES CIRCUIT – A circuit in which the current passes through each electrical unit in succession.

SHORT CIRCUIT – A path of lesser resistance which allows current to bypass its prescribed path.

STARTER – The electrical motor which converts the electrical energy of the battery to the mechanical energy required to start the engine. Also called a cranking motor or starting motor.

STATOR – The name of the laminated steel ring with loops of copper wire that surrounds the rotor in an alternator.

SOLENOID – An electromagnetic device used to perform a mechanical operation. A truck starter solenoid moves the drive pinion to mesh with the flywheel ring gear and holds it in position while the armature of the starter motor rotates to start the engine.

SLIP RING – A collector ring on the end of a rotor upon which the brushes ride.

VOLT – The unit of electrical pressure or electromotive force.

WATT – This unit of electrical power is calculated by multiplying amperes times voltage in a circuit. One horsepower equals 746 watts.

TECHNICAL DATA

MERITOR 22, 24, 28 SERIES ALTERNATORS

AMPERAGE OUTPUT VS. RPM SPEED IN HOT TEST CONDITION

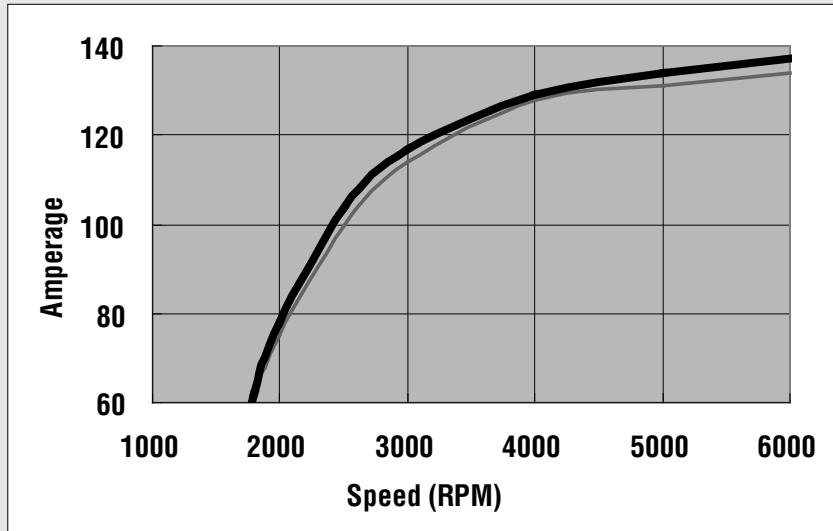

MERITOR —
OE —

RPM	OE	MERITOR
1600	29	30
1800	60	62
2000	75	78
2500	100	104
3000	114	117
4000	128	129
5000	131	134
6000	134	137

MERITOR 33, 34, 35, & 36 SERIES ALTERNATORS

HEAVY-DUTY BRUSHLESS ALTERNATORS

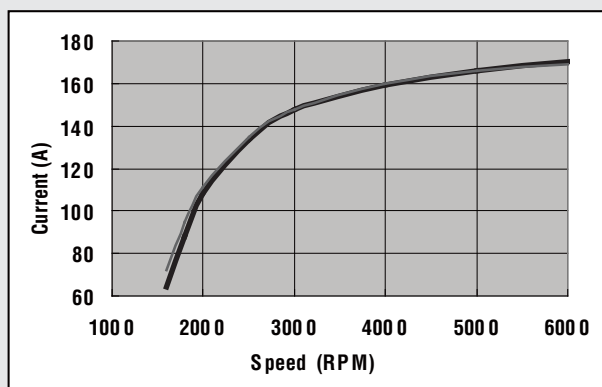

Overall performance curve shows same comparison to OEM.

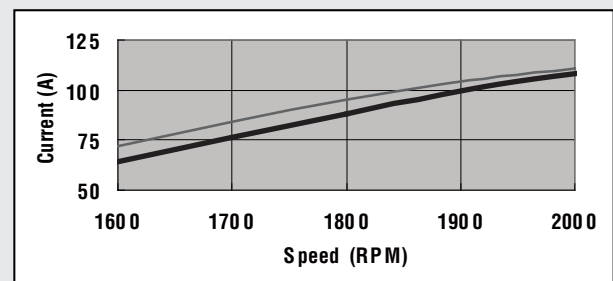

Meritor's superior performance output at low RPM compared to OEM output.

MERITOR —
OE —

TECHNICAL DATA

MERITOR 110 SERIES ALTERNATORS

ALTERNATOR PERFORMANCE CURVE

Part No.'s ALT-0050 & ALT-0051 12V, 160 Amp.

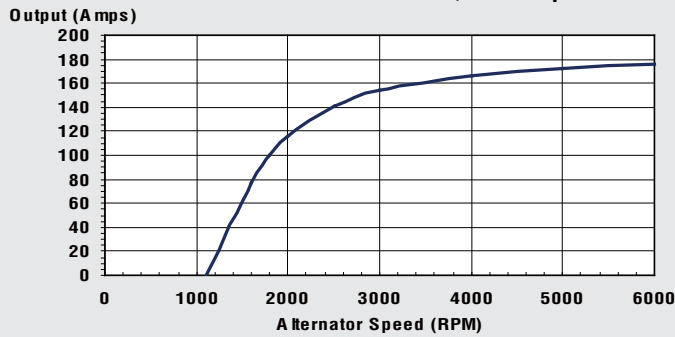

Part No.'s ALT-0060 & ALT-0061 12V, 165 Amp.

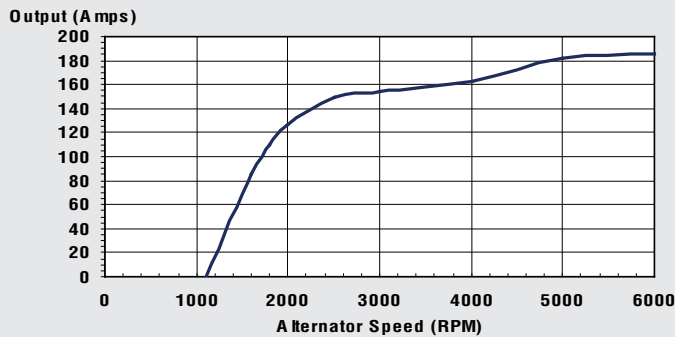

Part No.'s ALT-0070 & ALT-0071 12V, 175 Amp.

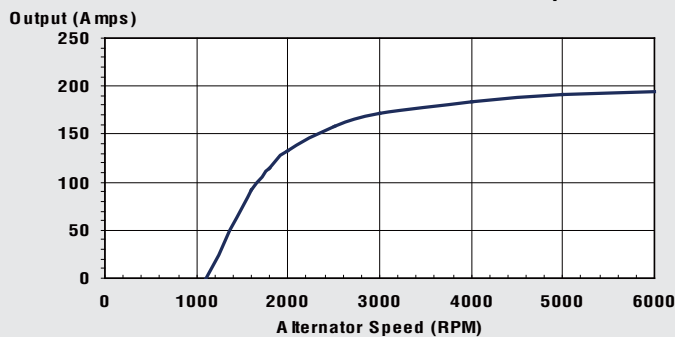

OUTPUT CURRENT TABLE

Alternator Rotor RPM	Equivalent Engine RPM	Amperage Output
1600 RPM	Start Up	77
1800 RPM	600	100
2000 RPM	660	116
2500 RPM	825	141
3000 RPM	1000	154
4000 RPM	1335	166
5000 RPM	1650	172
6000 RPM	2000	176

**116 Amp.
at Engine
Idle**

Alternator Rotor RPM	Equivalent Engine RPM	Amperage Output
1600 RPM	Start Up	86
1800 RPM	600	110
2000 RPM	660	126
2500 RPM	825	150
3000 RPM	1000	154
4000 RPM	1335	163
5000 RPM	1650	182
6000 RPM	2000	185

**126 Amp.
at Engine
Idle**

Alternator Rotor RPM	Equivalent Engine RPM	Amperage Output
1600 RPM	Start Up	92
1800 RPM	600	115
2000 RPM	660	133
2500 RPM	825	158
3000 RPM	1000	171
4000 RPM	1335	184
5000 RPM	1650	191
6000 RPM	2000	194

**133 Amp.
at Engine
Idle**

TECHNICAL DATA

MERITOR 38 SERIES STARTERS

INDEPENDENT TEST RESULTS*

- Starters tested until failure or 25,000 cycles, whichever comes first
- Both Meritor and OE starters were installed and subjected to the same testing specification
- All starters performed similarly well until nearing the 21,000 cycles when the reduction in performance had been observed for all starters during the last 2,000 cycles
- The performance of both Meritor and OEM starters were compared and performed equally well for 21,000 cycles

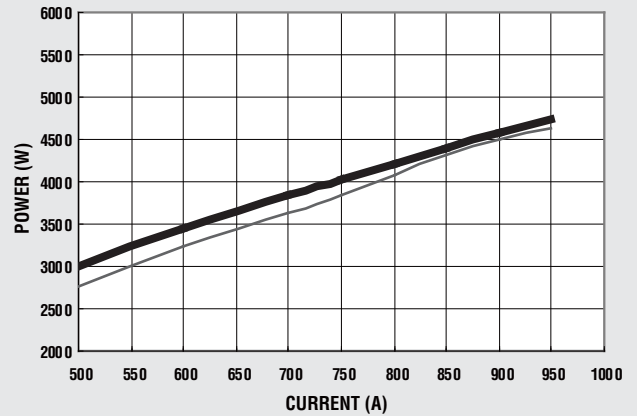
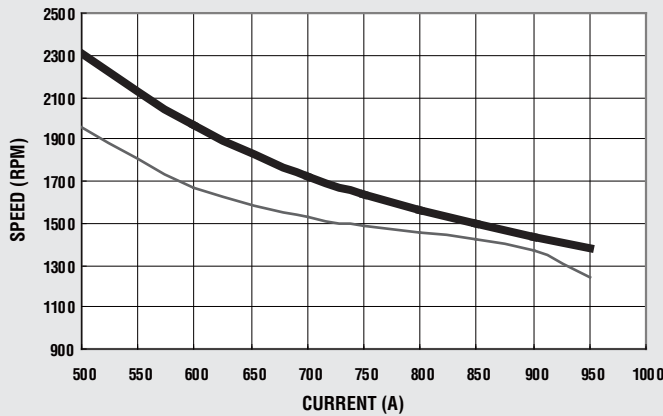
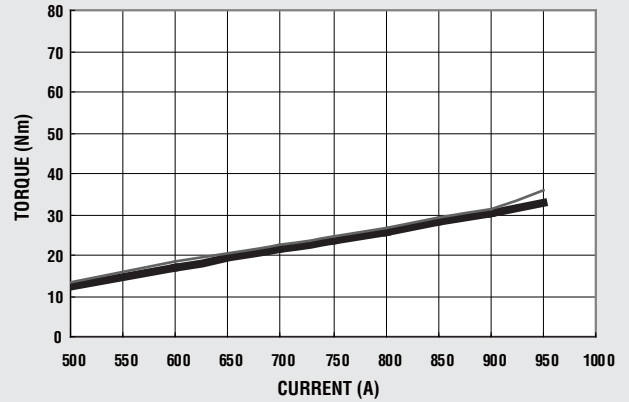

*Independent testing performed by Southwest Research Institute.

TECHNICAL DATA

MERITOR 39 SERIES STARTERS

Speed Performance

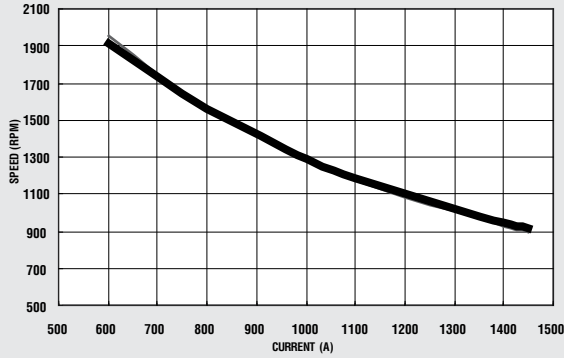

Torque Performance

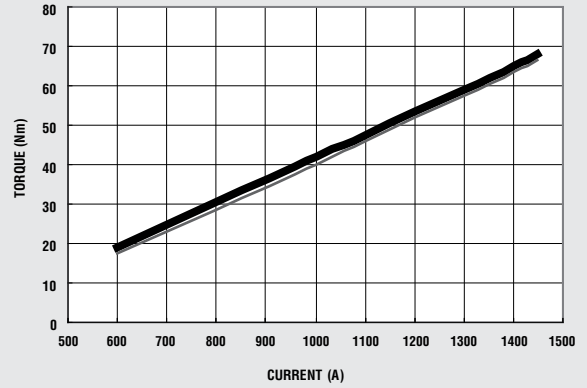

MERITOR	
OE	

Power Performance

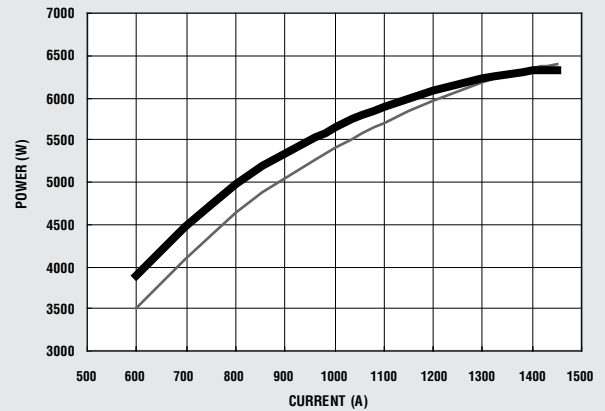

NOTES

MERITOR AFTERMARKET PARTS WARRANTY

We warrant all new parts for one year from date of shipment to the buyer against defective material or workmanship (but not against damage caused by accident, abuse or improper installation, maintenance or repair) when such parts are used on vehicles the specifications of which have been approved by our Engineering Department.

As the exclusive remedy under this warranty, we will, at our option, repair or replace such parts free of charge, or take back the nonconforming parts and refund the monies paid by buy for such parts, if found on examination by us to be nonconforming and if any necessary return charges are prepaid.

If it is necessary to return any parts under this warranty, buyer agrees not to make any deduction on account thereof from remittances on current accounts while claims are in the process of disposition. Any expense incurred without our consent for repairs or replacement will not be allowed.

THIS WARRANTY IS EXPRESSLY IN LIEU OF ALL OTHER WARRANTIES OR CONDITIONS, EXPRESS, IMPLIED OR STATUTORY, INCLUDING ANY IMPLIED WARRANTY OF MERCHANTABILITY OR FITNESS FOR PARTICULAR PURPOSE. IN NO EVENT SHALL SELLER BE LIABLE FOR INCIDENTAL OR CONSEQUENTIAL DAMAGES OF ANY NATURE.

Only genuine Meritor replacement parts are covered by this aftermarket parts warranty.



MERITOR®

Meritor Heavy Vehicle Systems, LLC
7975 Dixie Highway
Florence, KY 41042 USA

For more information:

U.S. 888-725-9355

Canada 800-387-3889

XpresswayPlus.Meritor.com

meritor.com

Litho in USA Issued 6-11
PB-11103 (47865/11900)
©2011 Meritor, Inc.

Vehicle models, brands and names depicted herein are the property of their respective owners, and are not in any way associated with Meritor, Inc., or its affiliates.